

Titulo: <b>RM#131 - 80" x 16" x 35mm - Knotty</b>						
<b>SQUARE ONE</b> BUILDING PRODUCTS	Client	SQUARE ONE				
	Designer	Renato Cavilia	Approval	Charles Agostini	Reviewed by	Luiz Antonio
	Date	26-08-2022	Date	26-08-2022	Review Date	26-08-2022

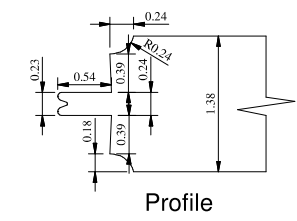

Titulo: <b>RM#131 - 80" x 18" x 35mm - Knotty</b>						
	Client	SQUARE ONE				
	Designer	Renato Cavilia	Approval	Charles Agostini	Reviewed by	Luiz Antonio
	Date	23/03/2010	Date	23/03/2010	Review Date	15-02-2021

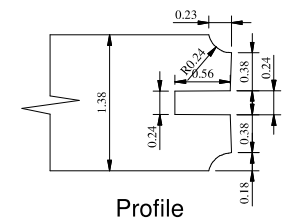
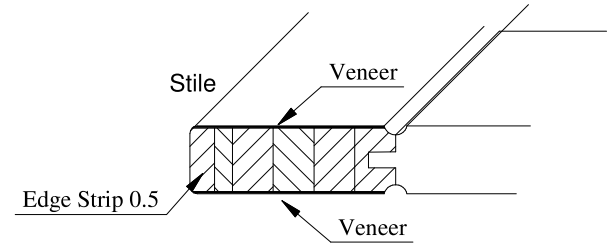
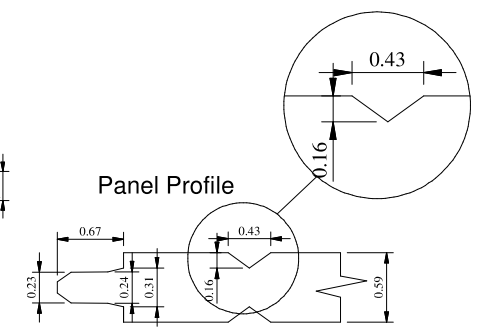
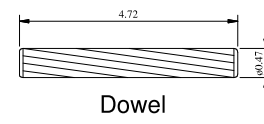
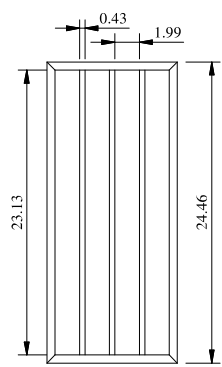
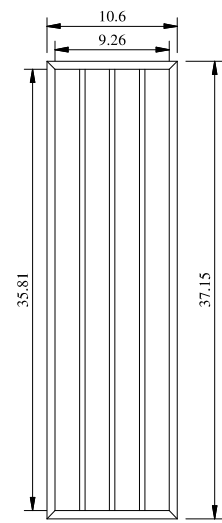
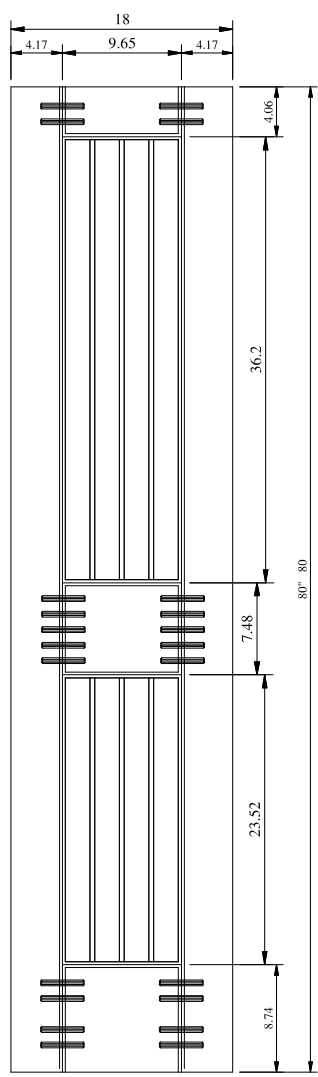
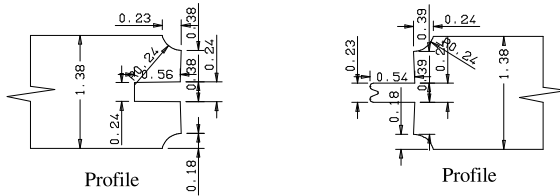
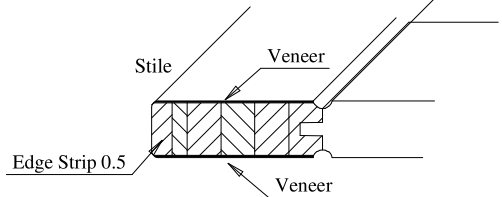
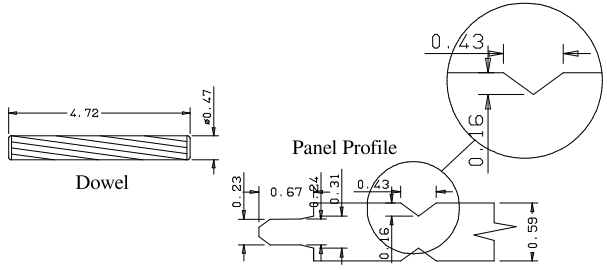
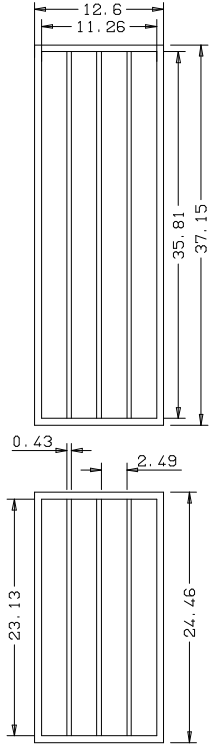
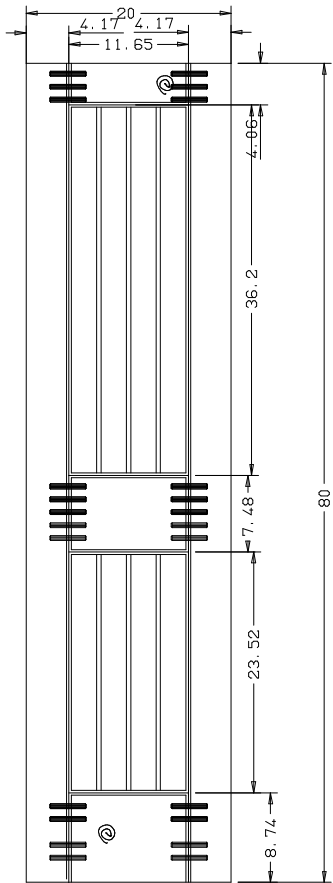

Titulo: <b>RM#131 - 80" x 20" x 35mm - Knotty</b>					
<b>SQUARE ONE</b> BUILDING PRODUCTS	Client	963- Square One			
	Designer	Luiz Antônio	Approval	Charles	Reviewed by Luiz Antonio
	Date	13-04-2021	Date	13-04-2021	Review Date 13-04-2021

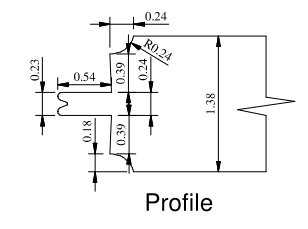
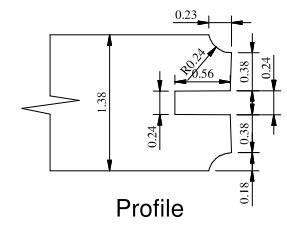
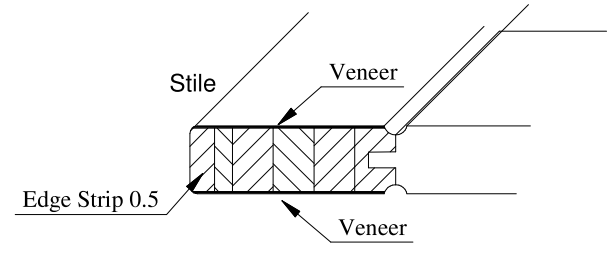
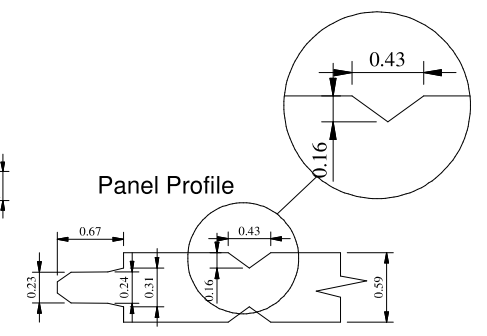
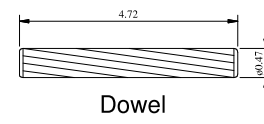
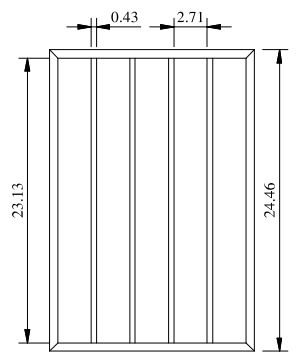
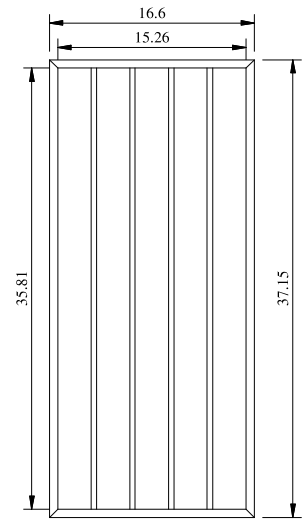
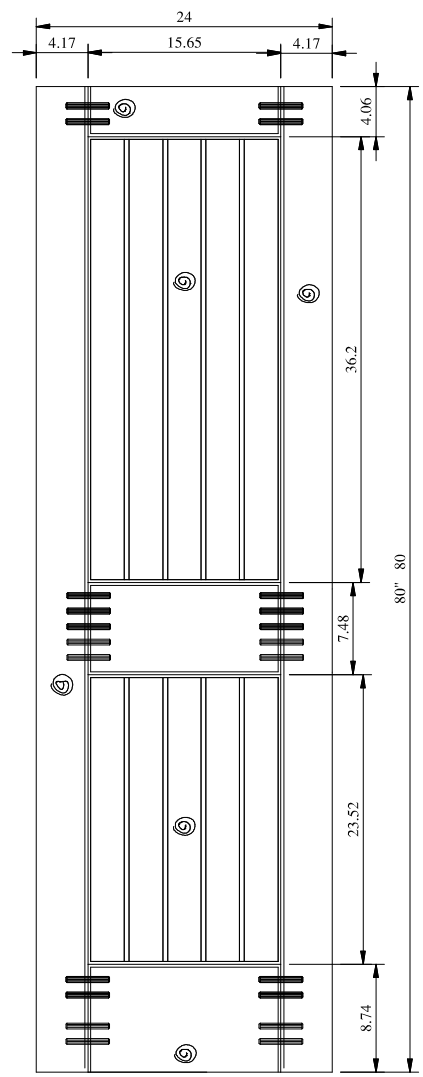

Titulo: <b>RM#131 - 80" x 24" x 35mm - Knotty</b>					
<b>SQUARE ONE</b> BUILDING PRODUCTS	Client	SQUARE ONE			
	Designer	Renato Cavilia	Approval	Charles Agostini	Reviewed by Luiz Antonio
	Date	23/03/2010	Date	23/03/2010	Review Date 15-02-2021

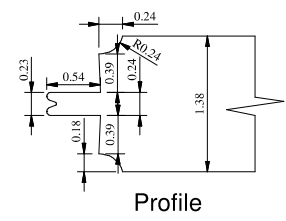
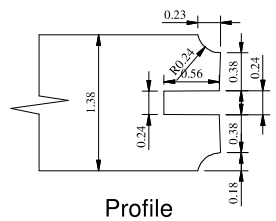
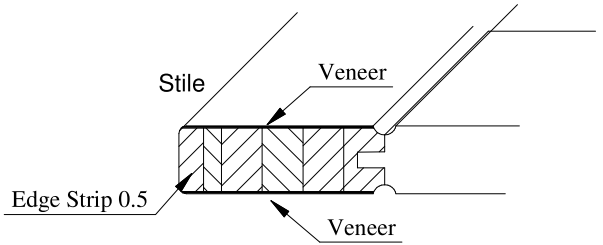
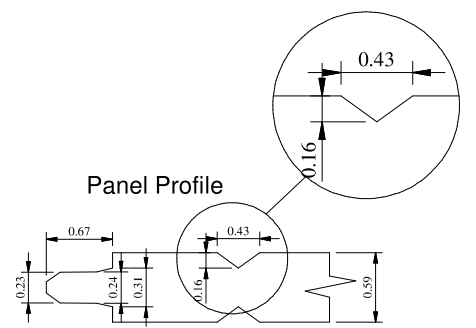
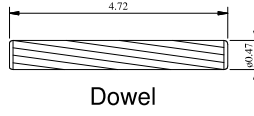
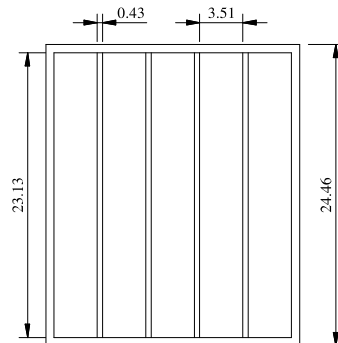
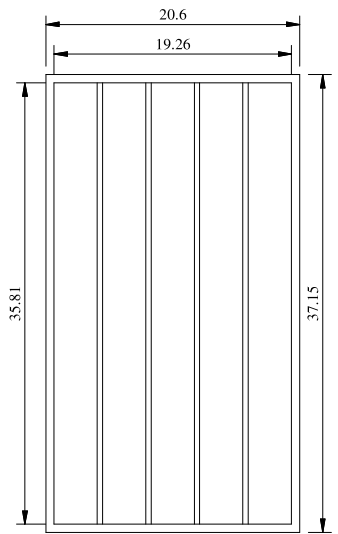
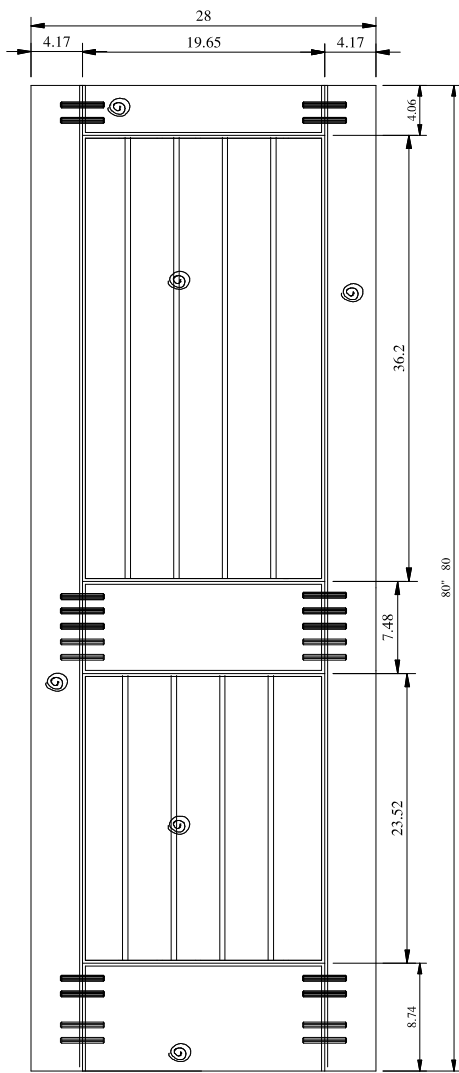

Titulo: <b>RM#131 - 80" x 28" x 35mm - Knotty</b>						
	Client	SQUARE ONE				
	Designer	Renato Cavilia	Approval	Charles Agostini	Reviewed by	Luiz Antonio
	Date	23/03/2010	Date	23/03/2010	Review Date	15-02-2021

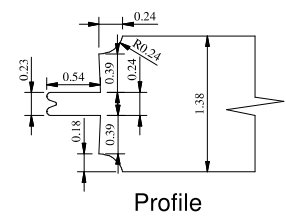
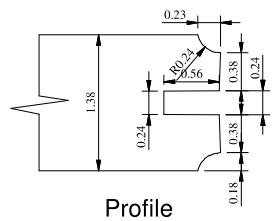
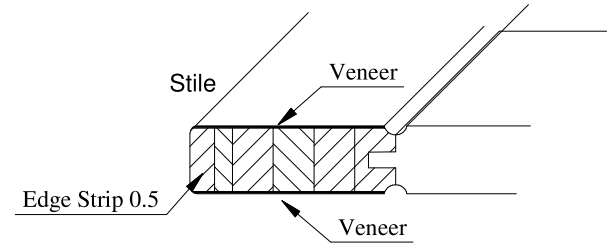
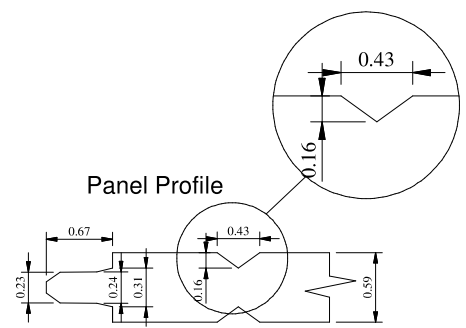
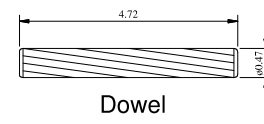
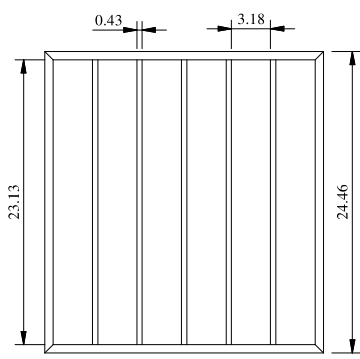
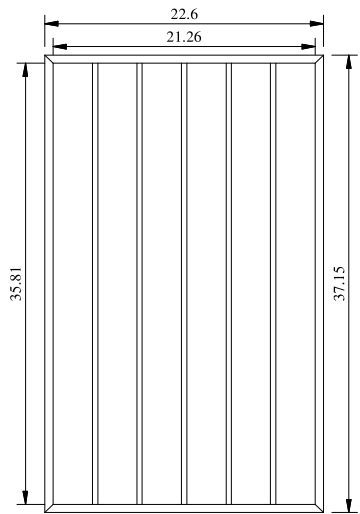
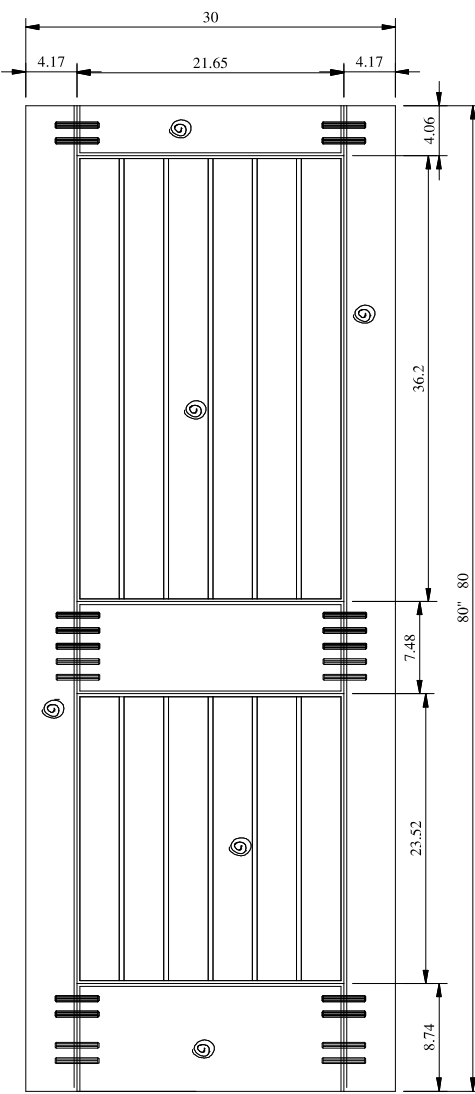

Titulo: <b>RM#131 - 80" x 30" x 35mm - Knotty</b>						
<b>SQUARE ONE</b> BUILDING PRODUCTS	Client	SQUARE ONE				
	Designer	Renato Cavilia	Approval	Charles Agostini	Reviewed by	Luiz Antonio
	Date	23/03/2010	Date	23/03/2010	Review Date	15-02-2021

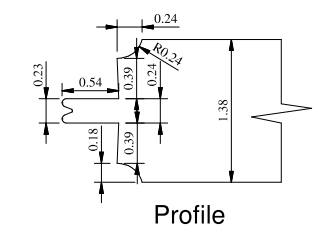
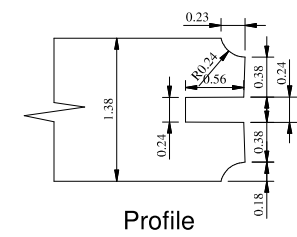
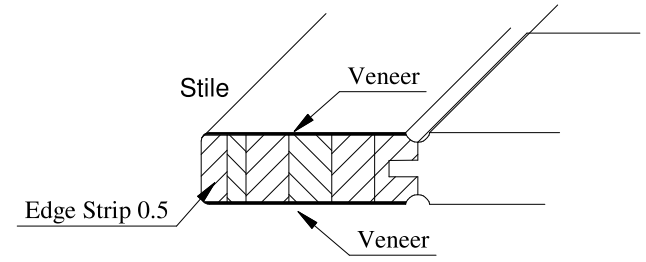
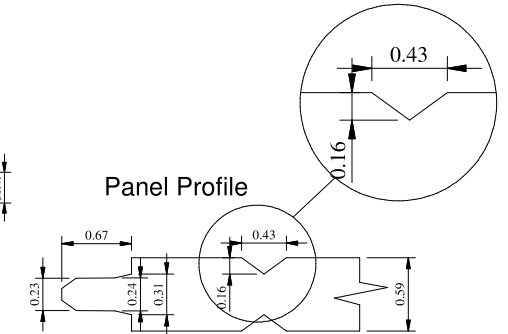
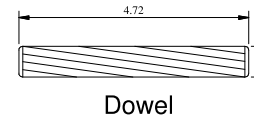
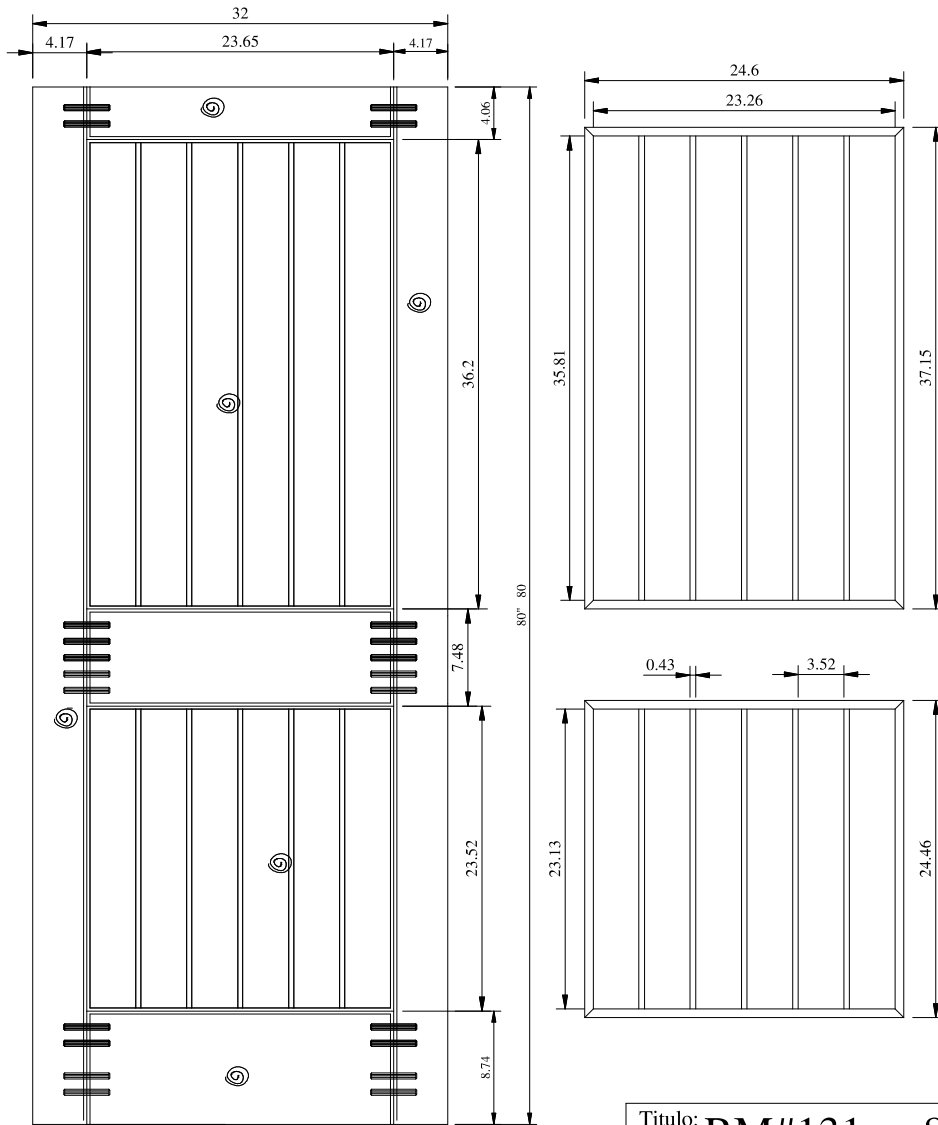

Titolo: <b>RM#131 - 80" x 32" x 35mm - Knotty</b>				
	SQUARE ONE			
	Renato Cavilia		Charles Agostini	Luiz Antonio
	23/03/2010		23/03/2010	15-02-2021

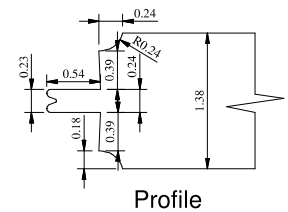
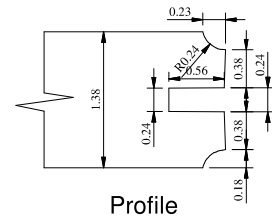
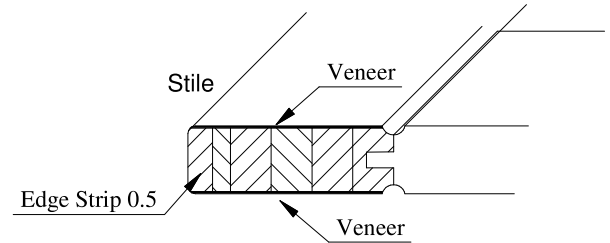
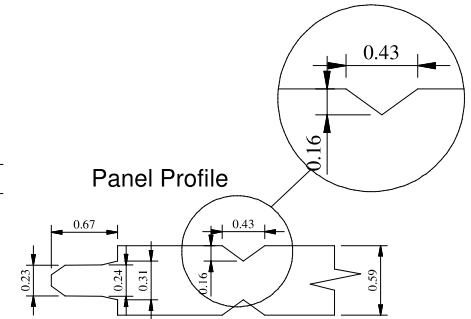
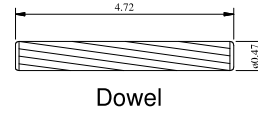
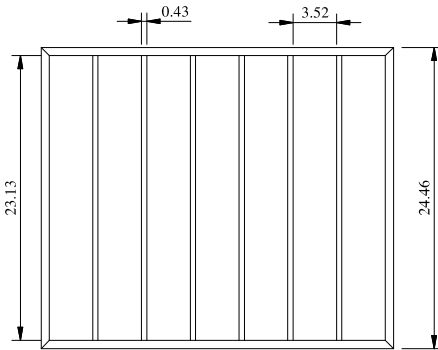
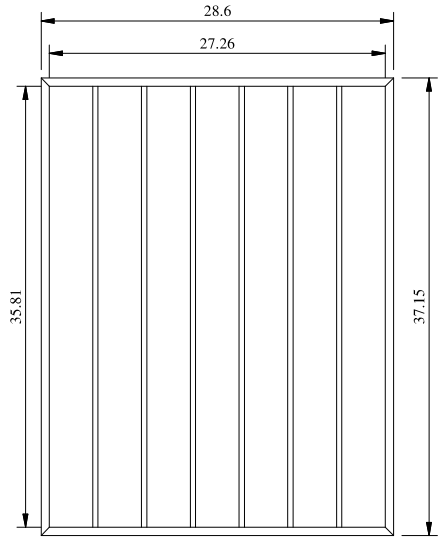
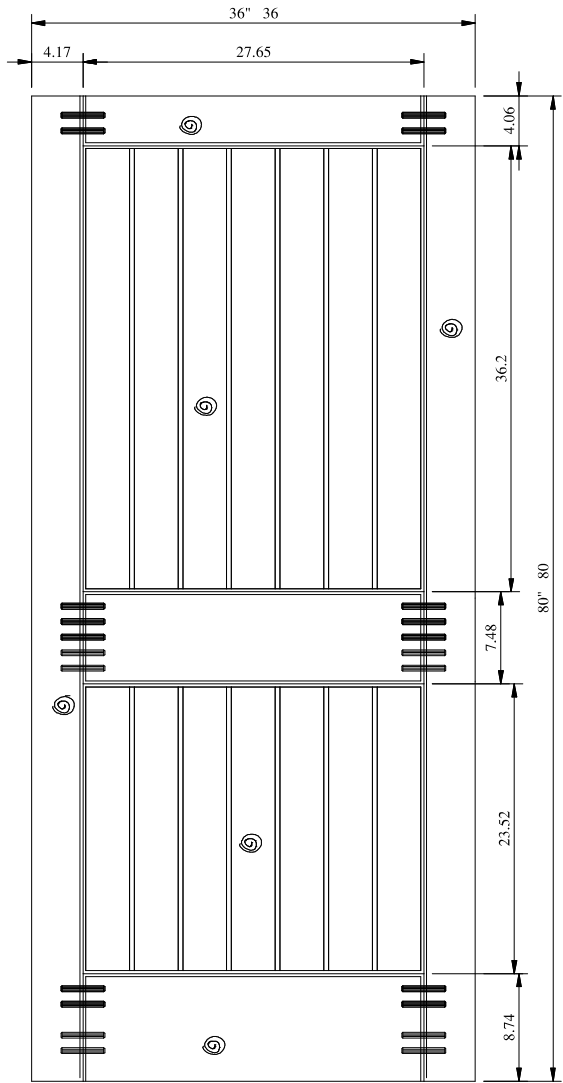

Titulo: RM#131 - 80" x 36" x 35mm - Knotty

**SQUARE ONE**  
BUILDING PRODUCTS

Client	SQUARE ONE				
Designer	Renato Cavilia	Approval	Charles Agostini	Reviewed by	Luiz Antonio
Date	23/03/2010	Date	23/03/2010	Review Date	15-02-2021



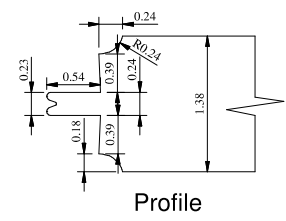
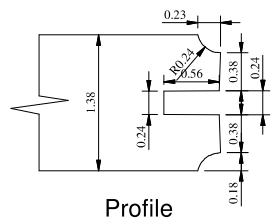
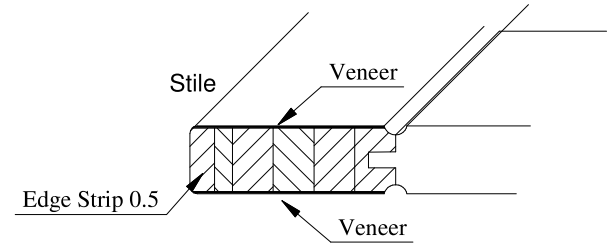
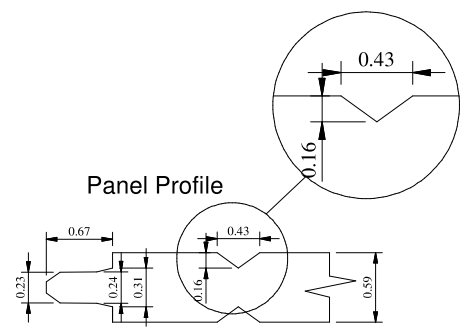
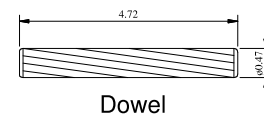
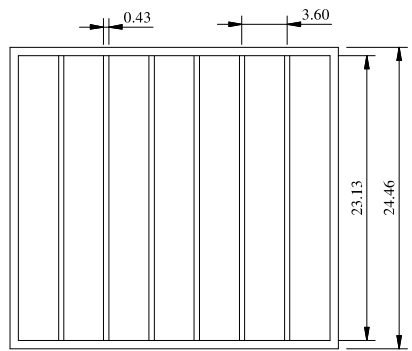
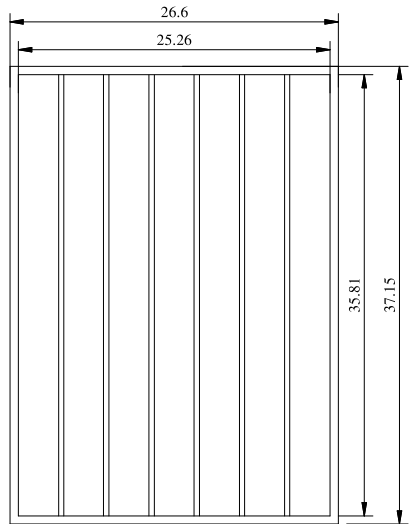
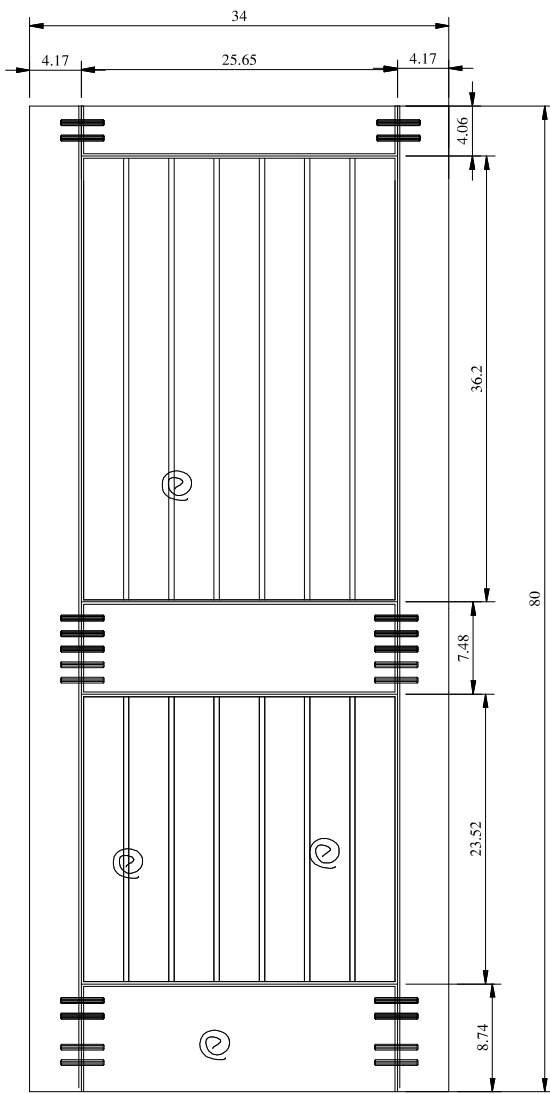

Titulo: <b>RM#131 - 80" x 34" x 35mm - Knotty</b>						
<b>SQUARE ONE</b> BUILDING PRODUCTS	Client	SQUARE ONE				
	Designer	Luiz Antonio Cirico	Approval	Charles Agostini	Reviewed by	Luiz Antonio
	Date	23-04-2021	Date	23-04-2021	Review Date	23-04-2021