

Titulo: RM#132 - 80" x 16" x 35mm - Knotty					
SQUARE ONE BUILDING PRODUCTS	Client	SQUARE ONE			
	Designer	Luiz Antonio	Approval	Charles Agostini	Reviewed by Luiz Antonio
	Date	31-08-2022	Date	31-08-2022	Review Date 31-08-2022

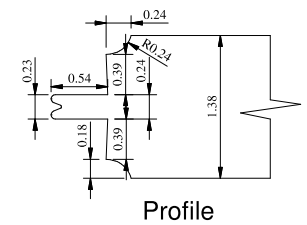

Titulo: RM#132 - 80" x 18" x 35mm - Knotty					
	Client	SQUARE ONE			
	Designer	Renato Cavilia	Approval	Charles Agostini	Reviewed by Luiz Antonio
	Date	23/03/2010	Date	23/03/2010	Review Date 15-02-2021

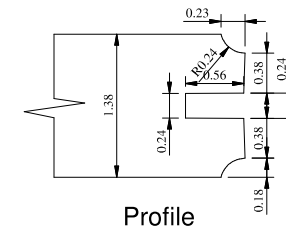
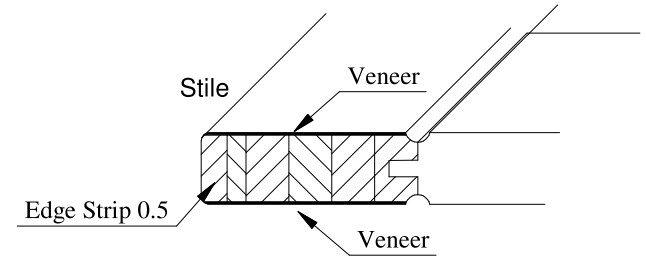
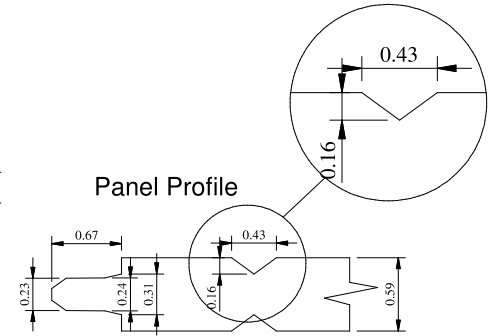
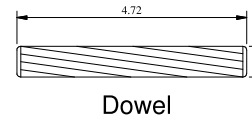
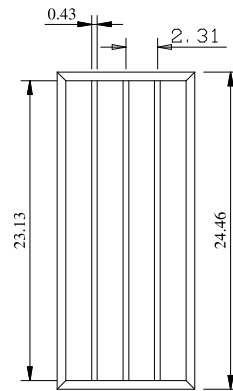
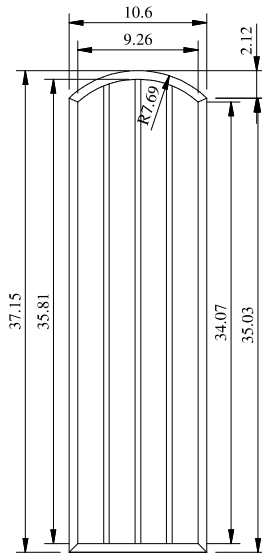
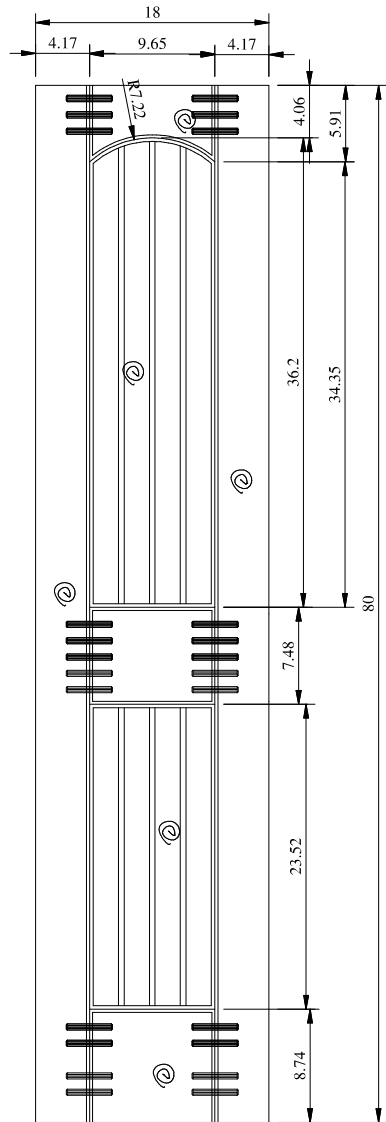
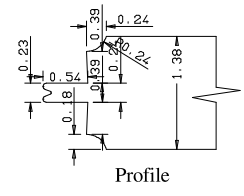
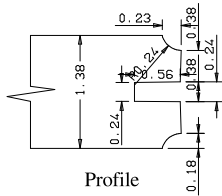
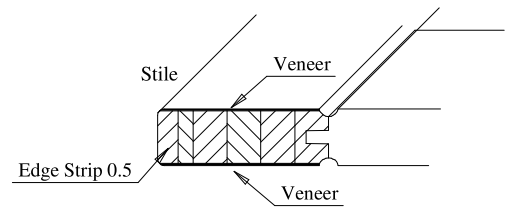
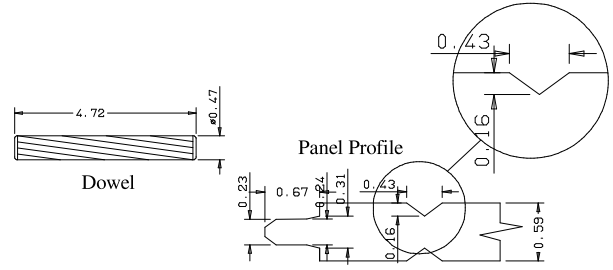
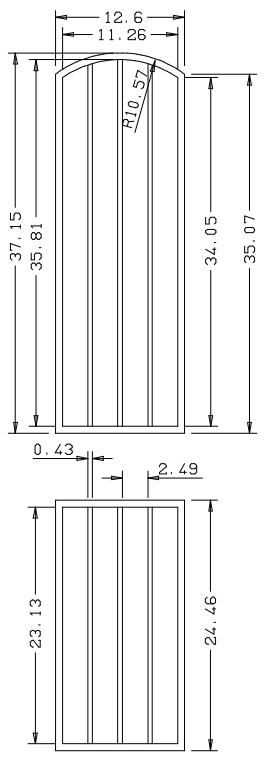
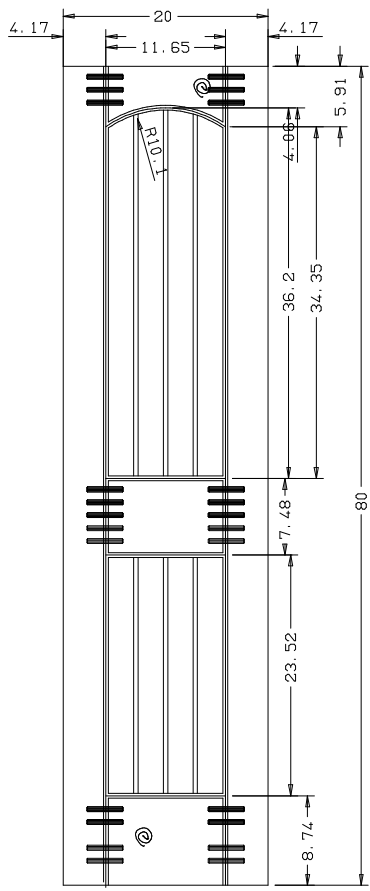

Titulo: RM#132 - 80" x 20" x 35mm - Knotty					
SQUARE ONE BUILDING PRODUCTS	Client	963- Square One			
	Designer	Luiz Antônio	Approval	Charles	Reviewed by Luiz Antonio
	Date	14-11-2018	Date	14-11-2018	Review Date 15-02-2021

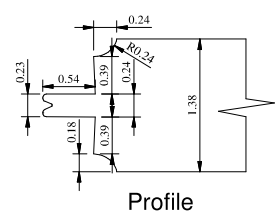
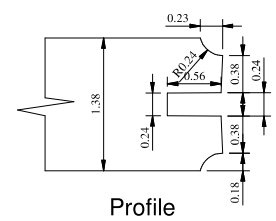
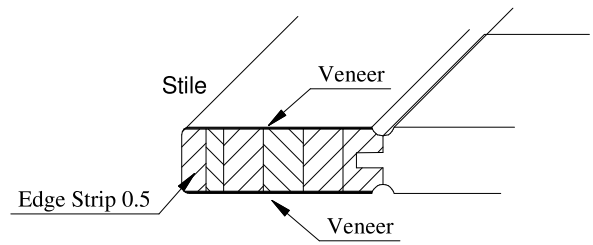
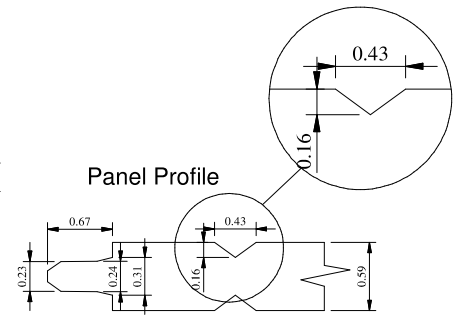
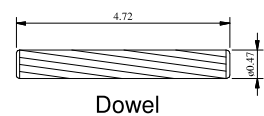
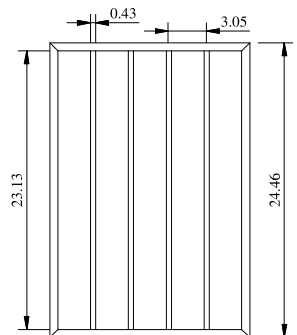
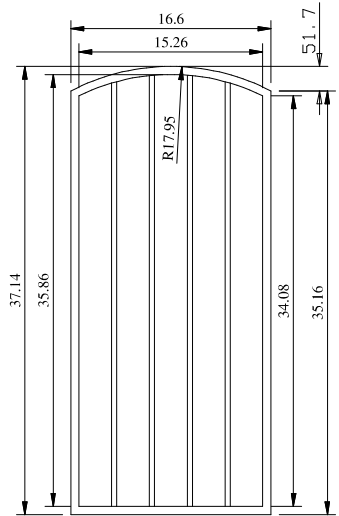
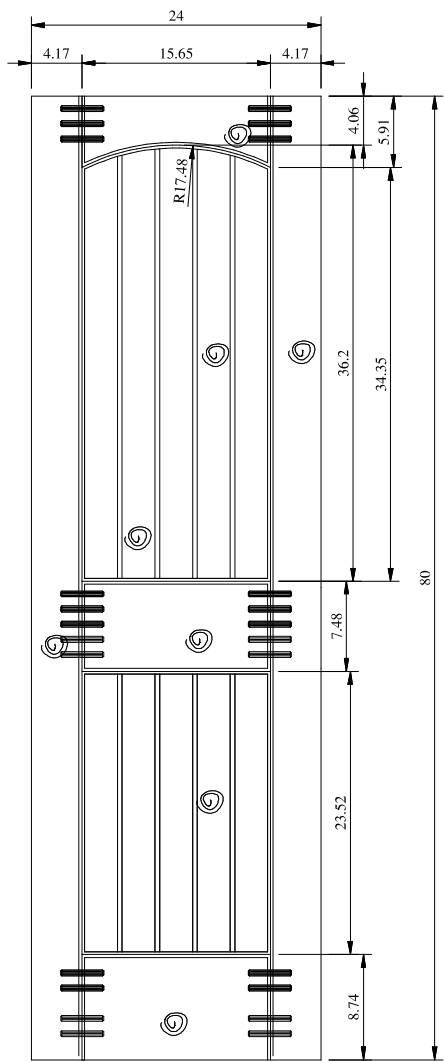

Titulo: RM#132 - 80" x 24" x 35mm - Knotty					
	Client	SQUARE ONE			
	Designer	Renato Cavilia	Approval	Charles Agostini	Reviewed by Luiz Antonio
	Date	23/03/2010	Date	23/03/2010	Review Date 15-02-2021

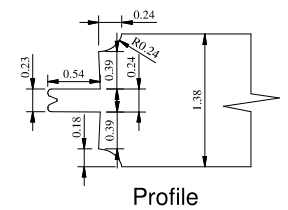
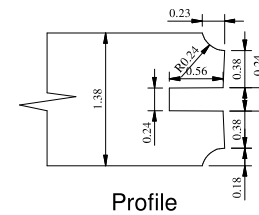
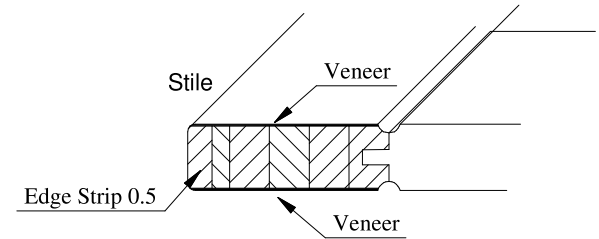
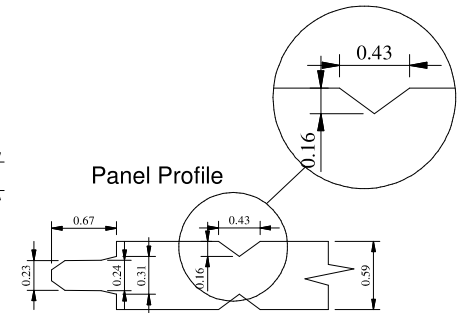
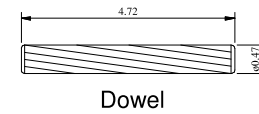
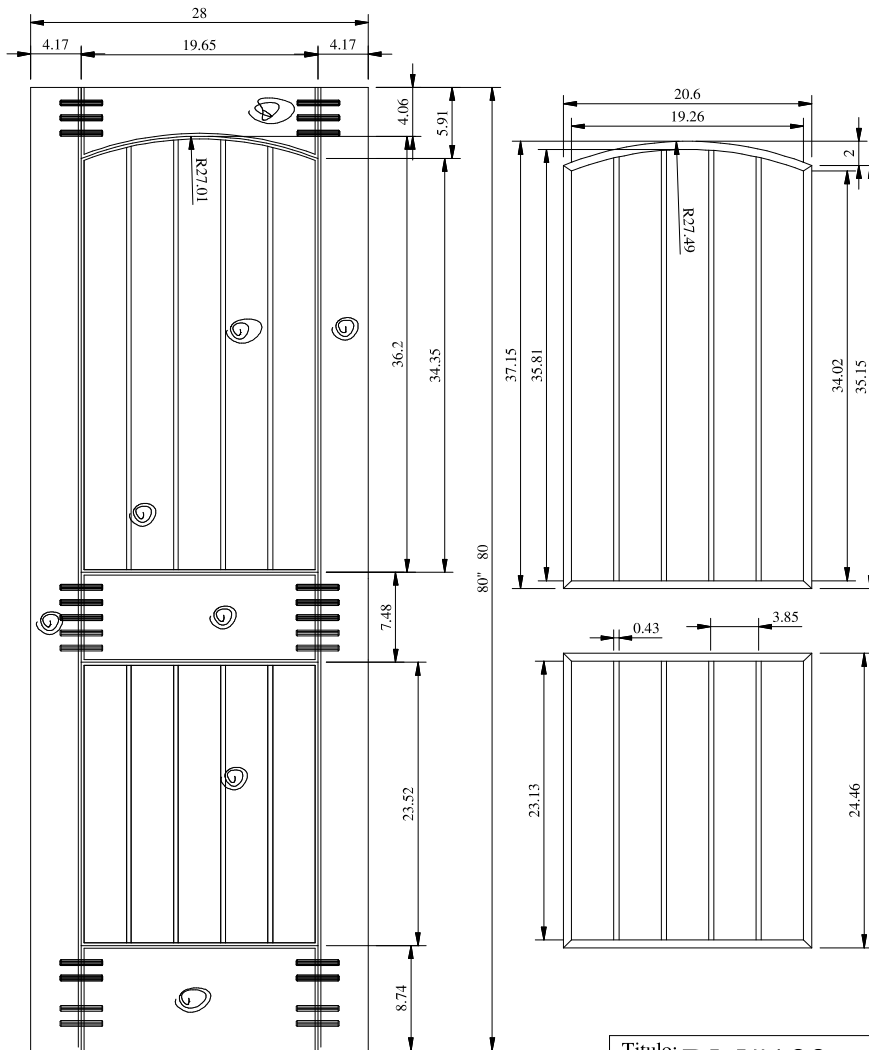

Titulo: RM#132 - 80" x 28" x 35mm - Knotty

	Client	SQUARE ONE				
	Designer	Renato Cavilia	Approval	Charles Agostini	Reviewed by	Luiz Antonio
	Date	23/03/2010	Date	23/03/2010	Review Date	15-02-2021

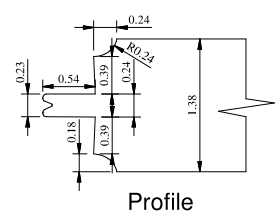
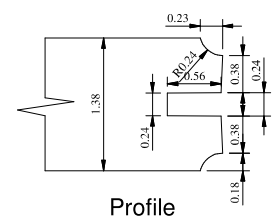
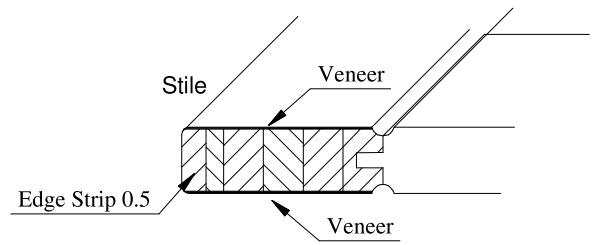
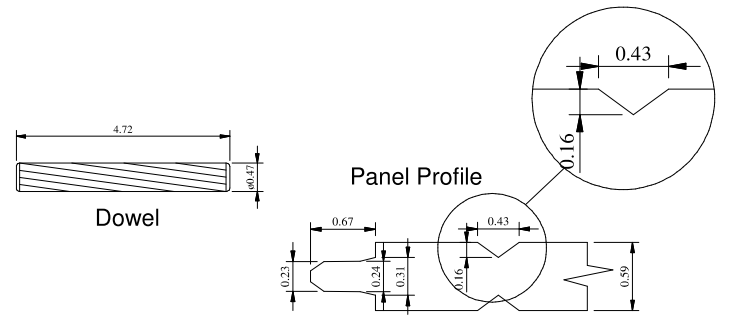
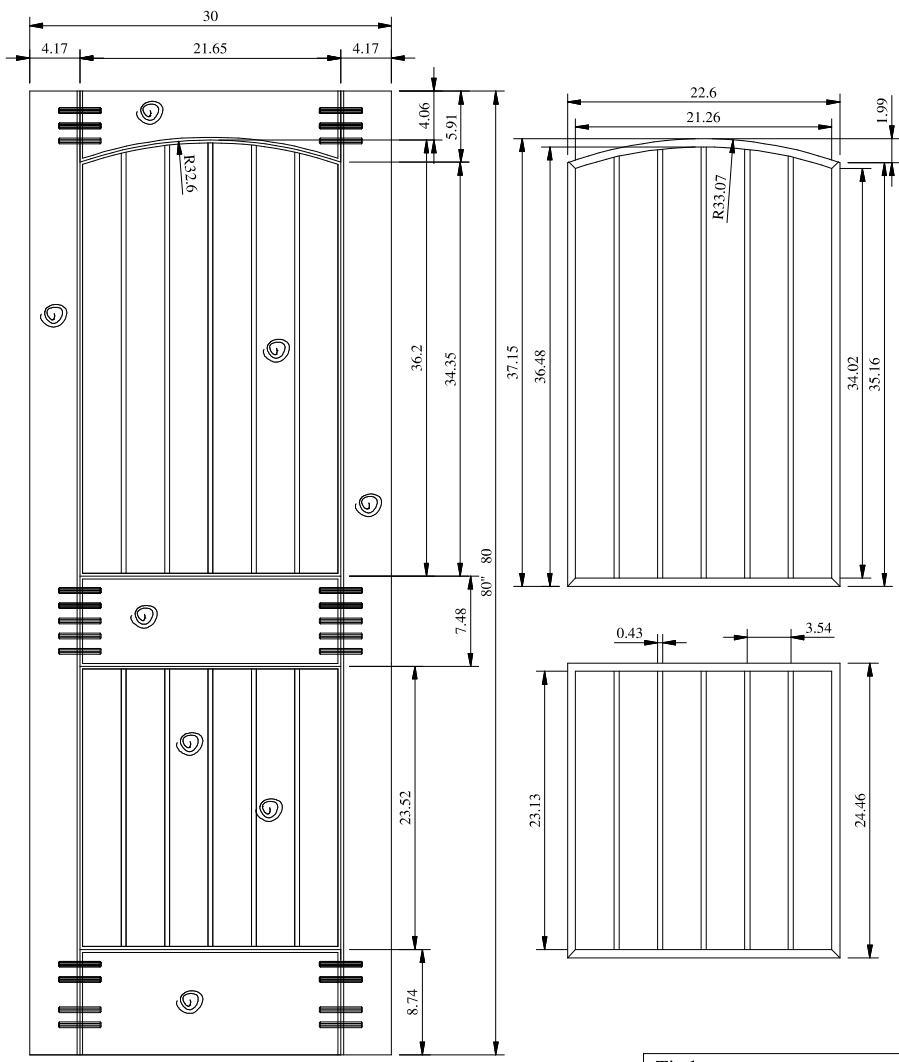

Titulo: RM#132 - 80" x 30" x 35mm - Knotty					
SQUARE ONE BUILDING PRODUCTS	Client	SQUARE ONE			
	Designer	Renato Cavilia	Approval	Charles Agostini	Reviewed by Luiz Antonio
	Date	23/03/2010	Date	23/03/2010	Review Date 15-02-2021

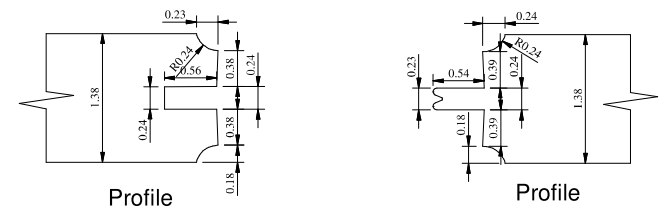
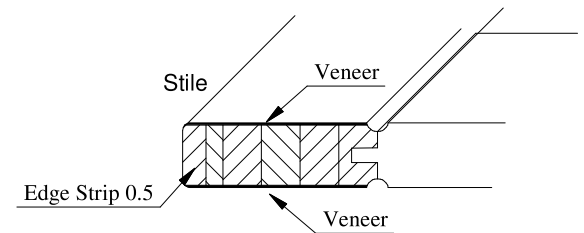
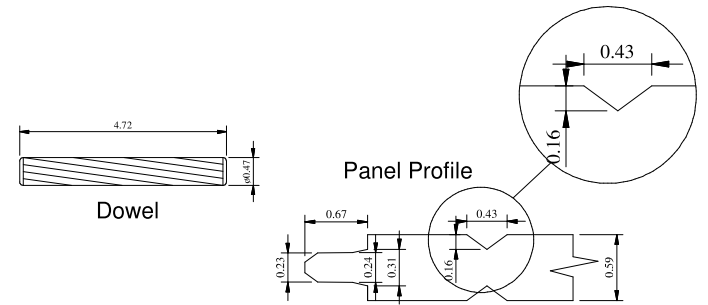
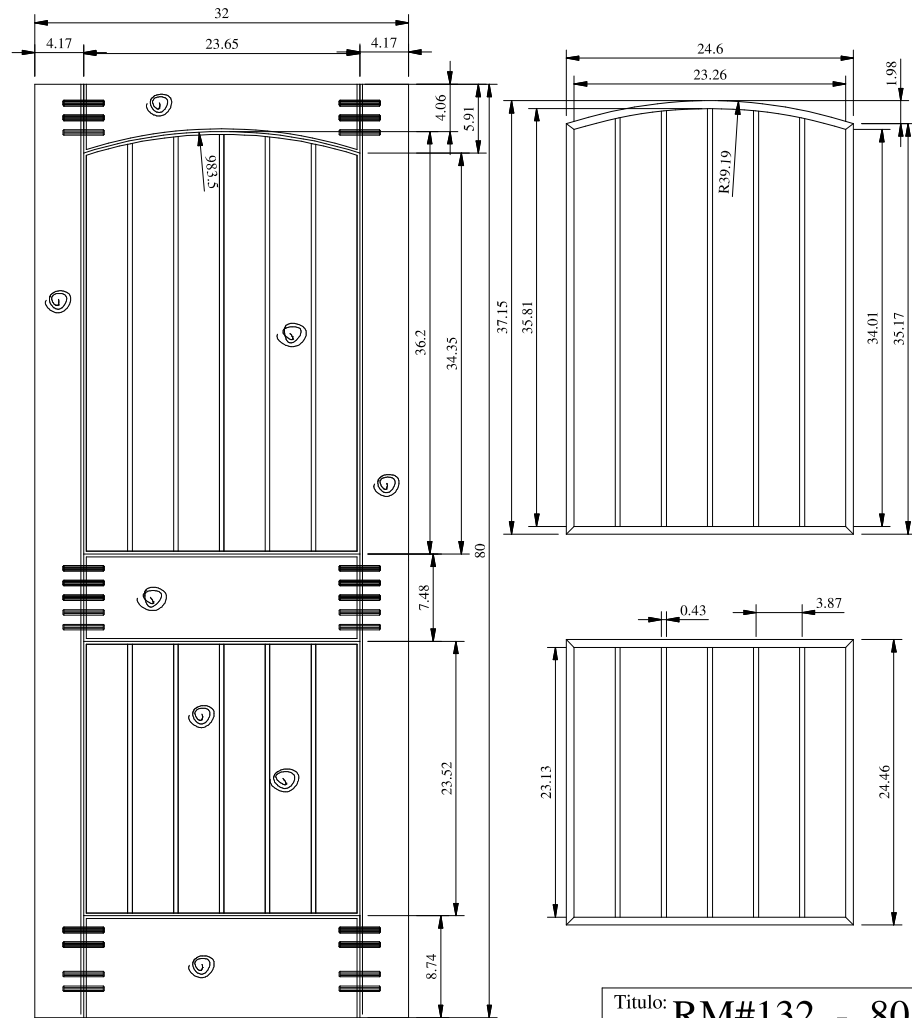

Titulo: RM#132 - 80" x 32" x 35mm - Knotty

SQUARE ONE
BUILDING PRODUCTS

Client	SQUARE ONE			
Designer	Renato Cavilia	Approval	Charles Agostini	Reviewed by
Date	23/03/2010	Date	23/03/2010	Review Date
				Luiz Antonio
				15-02-2021

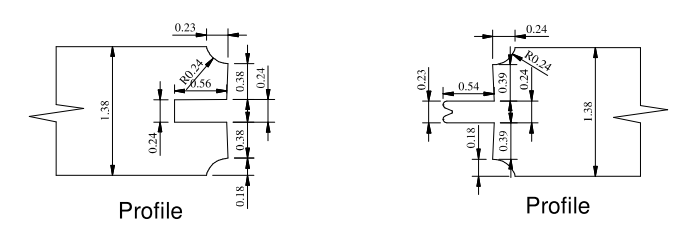
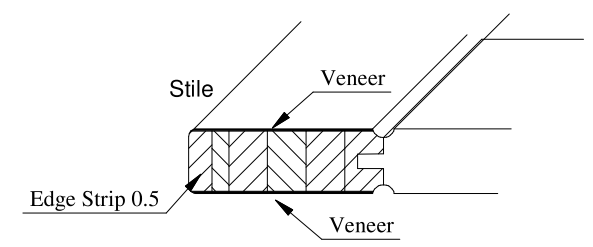
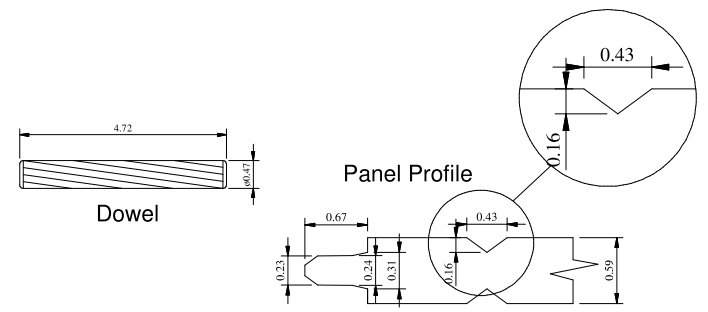
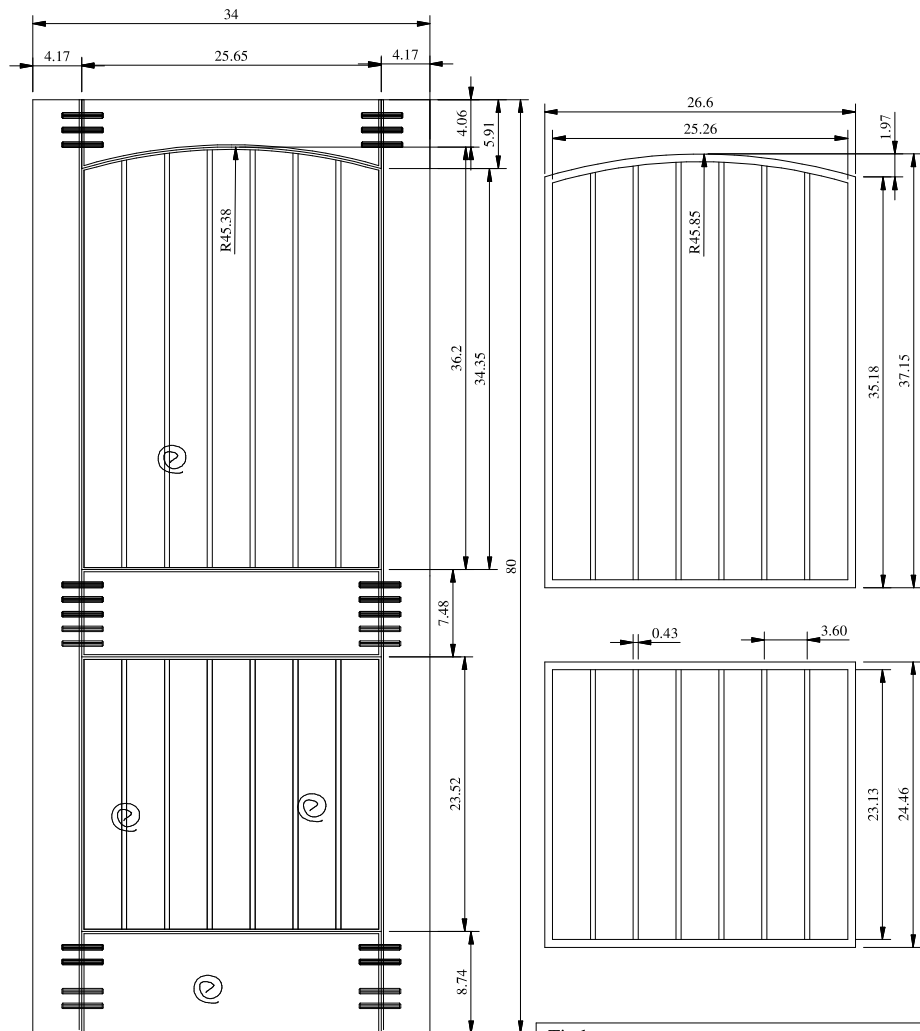

Titulo: RM#132 - 80" x 34" x 35mm - Knotty					
SQUARE ONE BUILDING PRODUCTS	Client	SQUARE ONE			
	Designer	Anderson	Approval	Charles Agostini	Reviewed by Luiz Antonio
	Date	07/01/2011	Date	07/01/2011	Review Date 15-02-2021

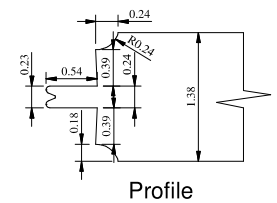
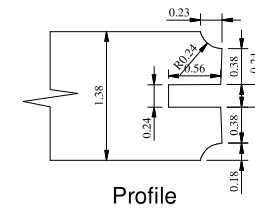
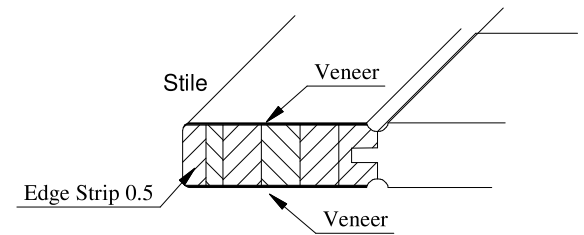
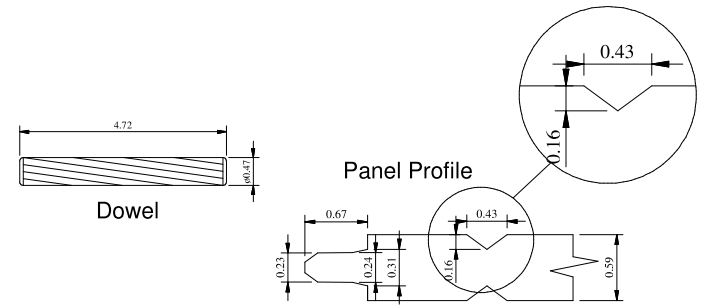
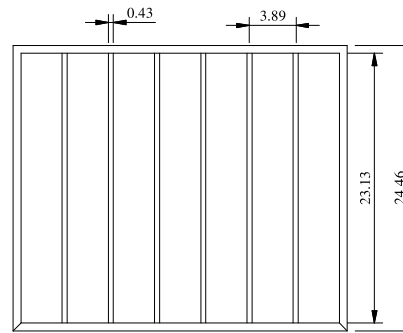
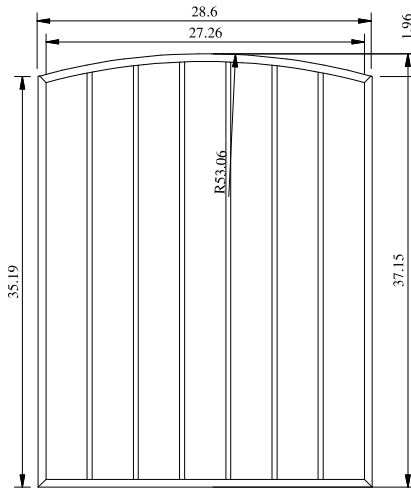
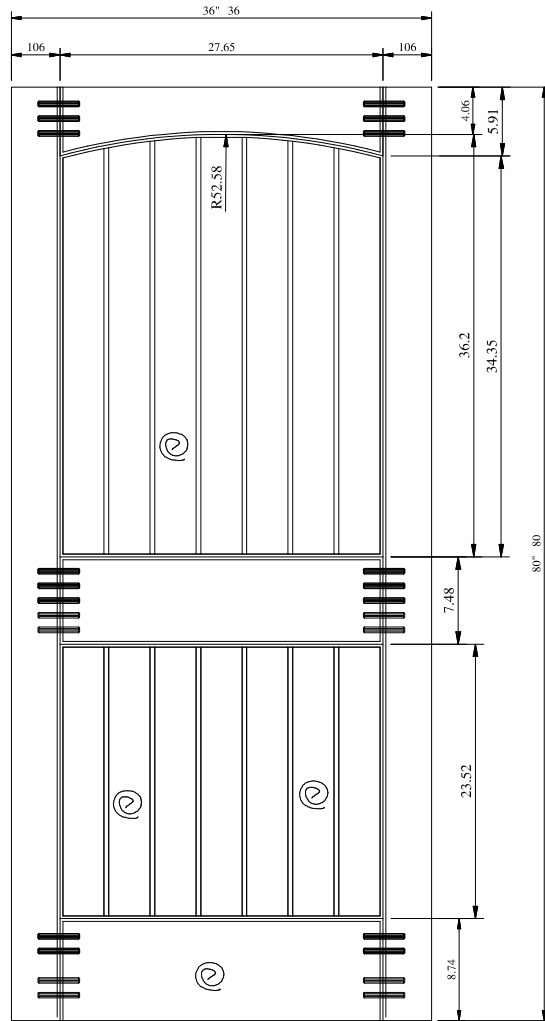

Titulo: RM#132 - 80" x 36" x 35mm - Knotty

SQUARE ONE
BUILDING PRODUCTS

Client	SQUARE ONE			
Designer	Renato Cavilia	Approval	Charles Agostini	Reviewed by Luiz Antonio
Date	23/03/2010	Date	23/03/2010	Review Date 15-02-2021