

Panel Profile

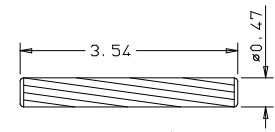

Dowel

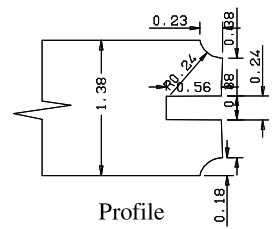
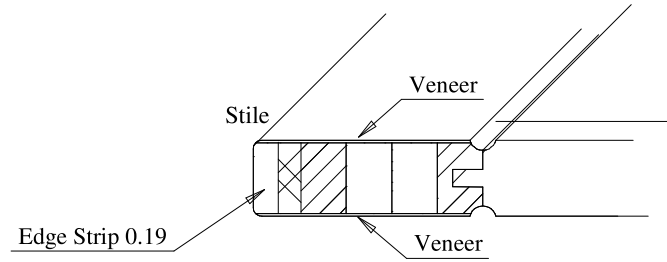

Profile

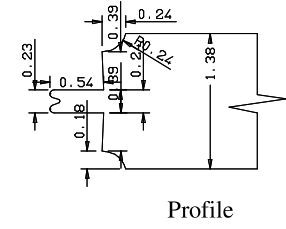

Profile

Titulo: RDM#1005 - 79" x 452,4 (17. 13-16) x 35mm - knotty						
	Client	Square One				
	Designer	Luiz Antonio Cirico	Approval	Charles	Reviewed by	Luiz Antonio
	Date	05-03-2020	Date	05-03-2020	Review Date	15-02-2021

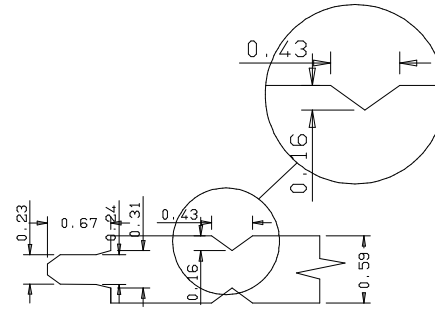
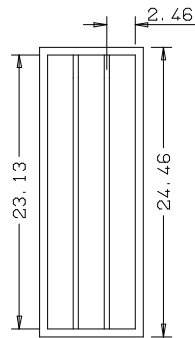
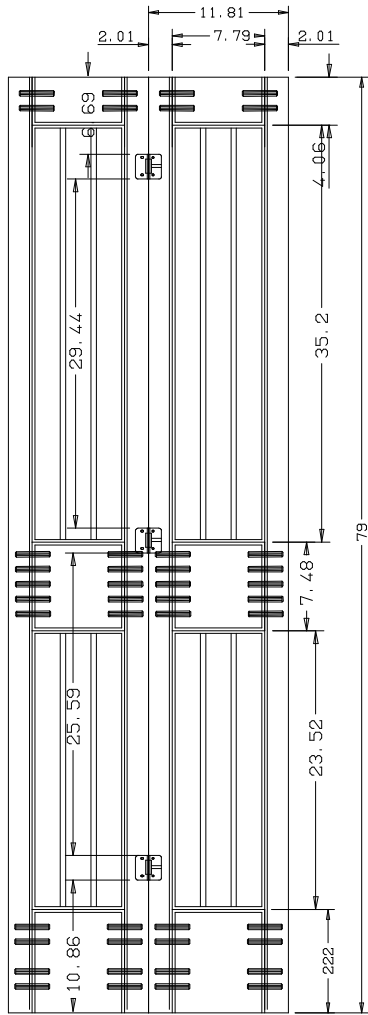

Panel Profile

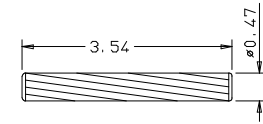

Dowel

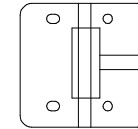

Hinge

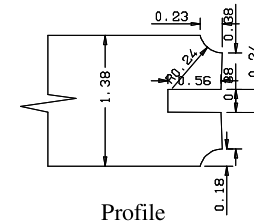
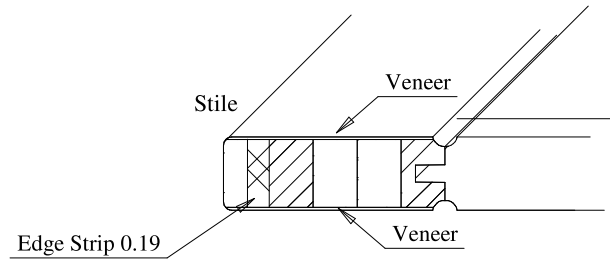

Profile

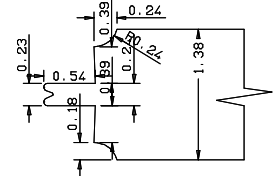

Profile

Titulo: RDM#1005 - 79" x 300,04 (11. 13-16) x 35mm - knotty							
	Client	Square One					
	Designer	Luiz Antonio Cirico	Approval	Charles	Reviewed by	Luiz Antonio	
	Date	03-05-2022	Date	03-05-2022	Review Date	03-05-2022	

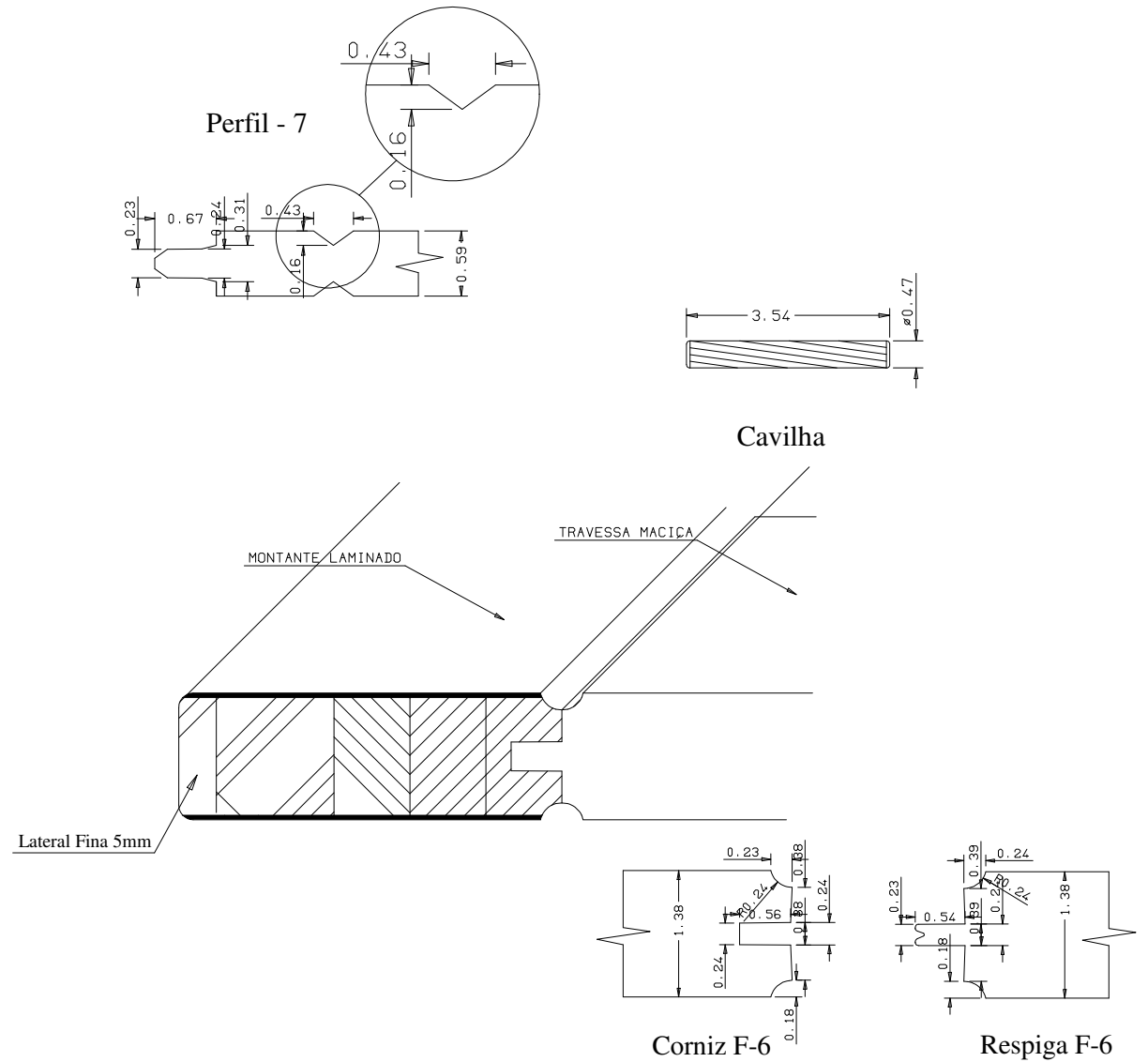
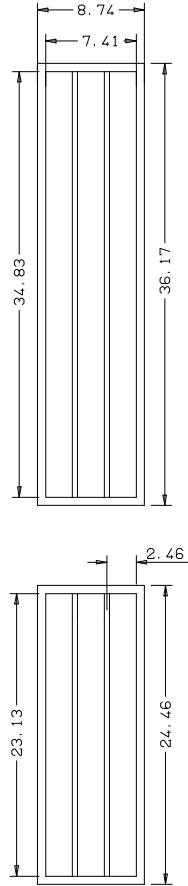
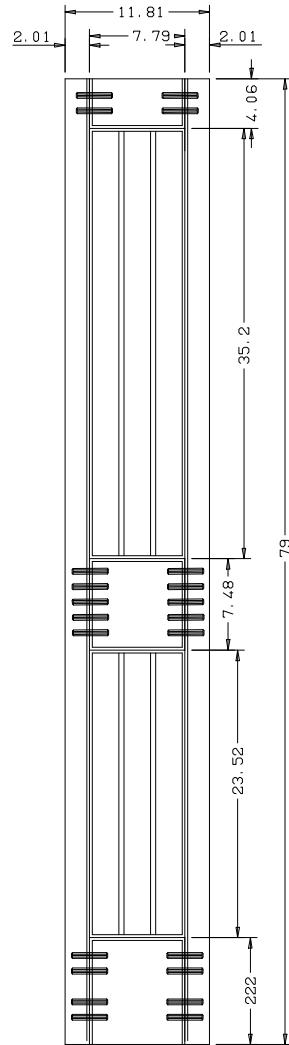

Título: RDM#1005 - 79" x 300,04 x 35mm - Knotty - Mont. Laminado				Escala	
				Nº Desenho	
Cliente	963- Square One	Aprovação	Charles	Nome:	
Desenhista	Luiz Antônio	Data	14-01-2019	Revisado Por	Luiz Antônio
Data	14-01-2019	Data	14-01-2019	Data Revisão	15-02-2021

Bifold 2 Panel V-Groove Square 79 X 17.81"

Summit

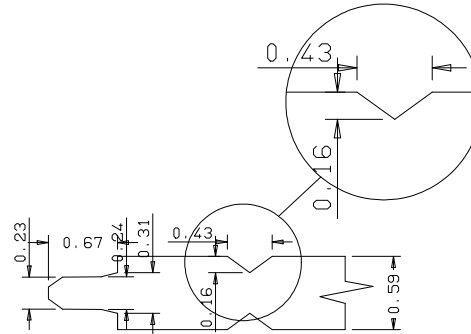
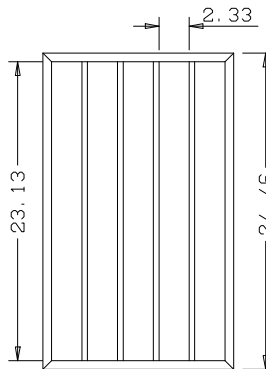
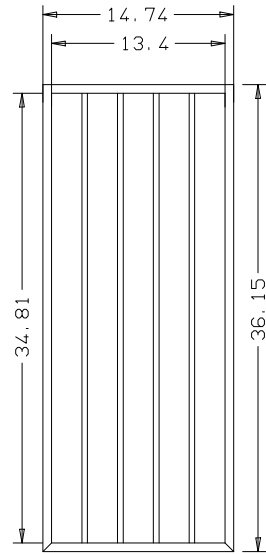
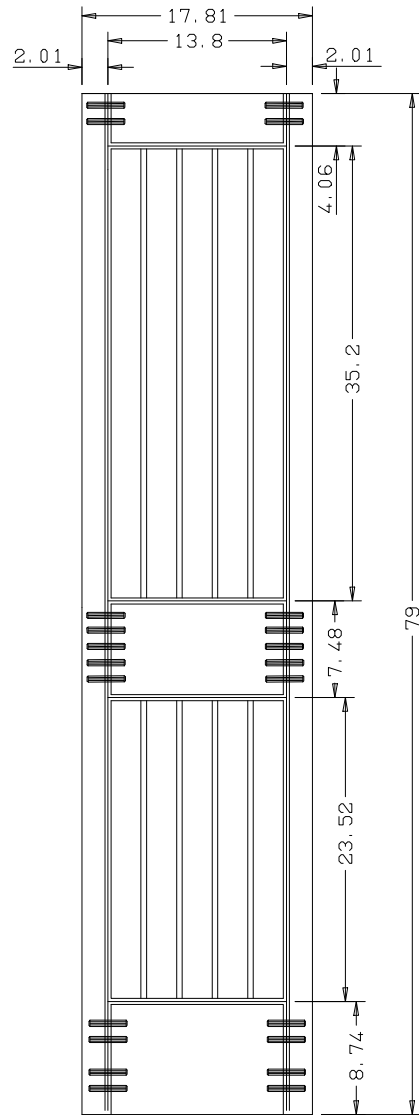

Panel Profile

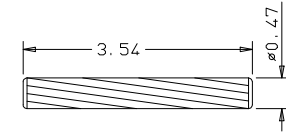

Dowel

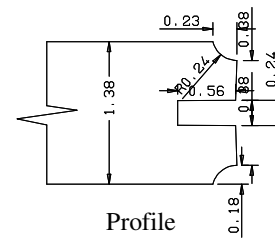
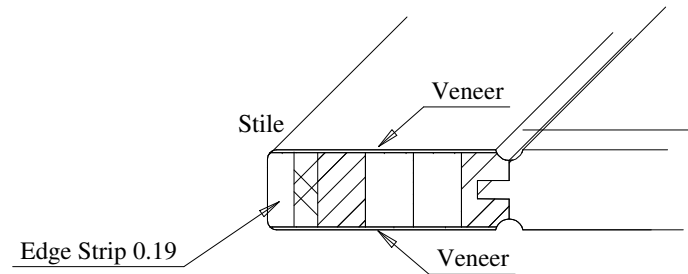

Profile

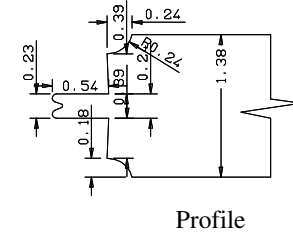

Profile

Titulo: RDM#1005 - 79" x 452,4 (17. 13-16) x 35mm - knotty

Client	Square One			Reviewed by	
Designer	Luiz Antonio Cirico	Approval	Charles	Reviewed by	Luiz Antonio
Date	05-03-2020	Date	05-03-2020	Review Date	15-02-2021

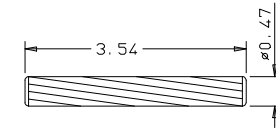
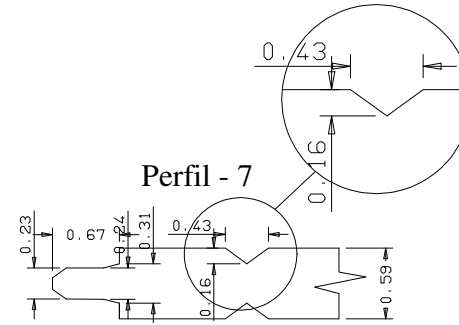
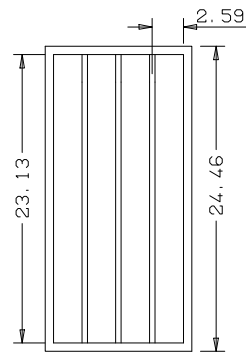
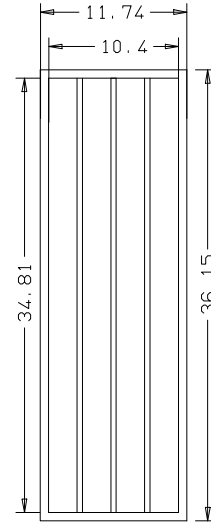
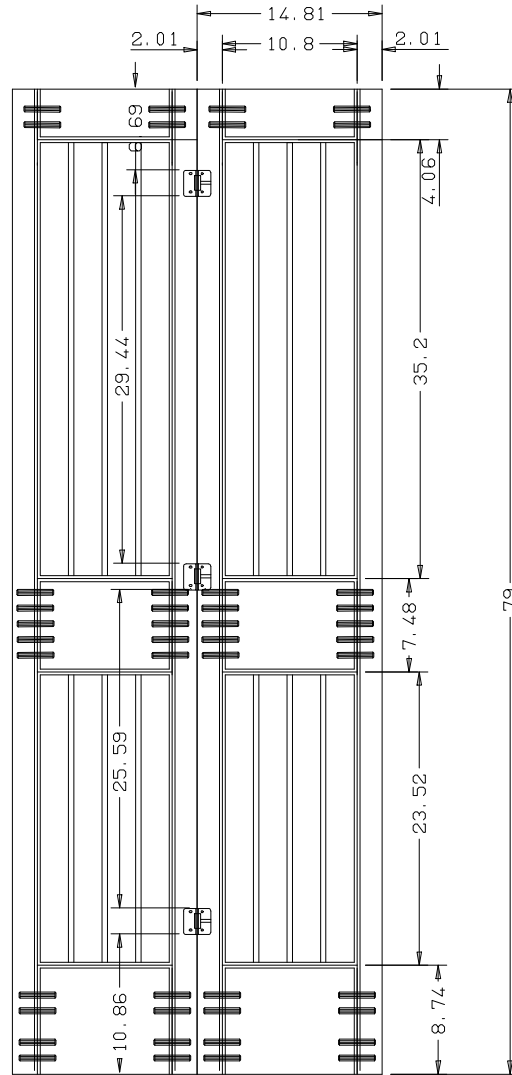

Cavilha

Dobradora da Johnson
Instalada

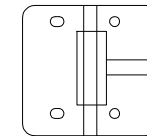

Dobr. Ref. Hinge Bulks
Paraf. Philips Cab. Redonda
Mais Kit e Trilho da Johnson

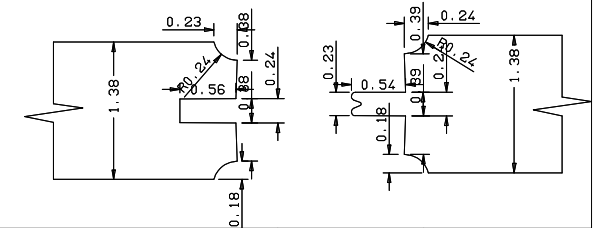
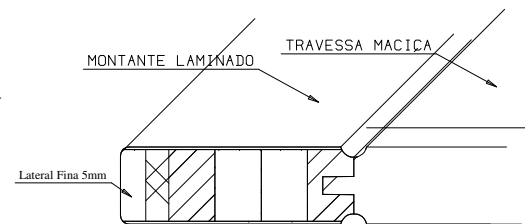

Titulo: RDM#1005 - 79" x 376,24 (14. 13-16) x 35mm - knotty

				Escala	
				Nº Desenho	
			Cliente	Square One	
			Desenhista	Luiz Antonio Cirico	
			Aprovação	Charles	
			Data	03-05-2022	03-05-2022
				Nome:	
				Revisado Por	Luiz Antonio
				Data Revisão	03-05-2022

Bifold 2 Panel V-Groove Square 36" - Johnson Hardware

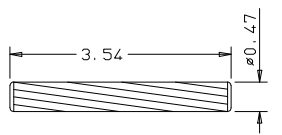
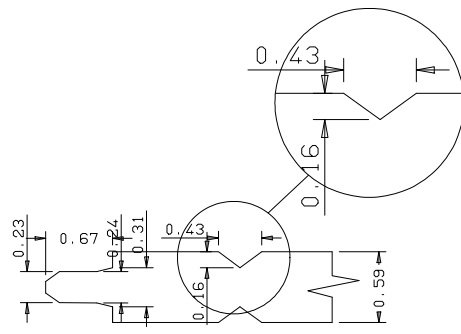
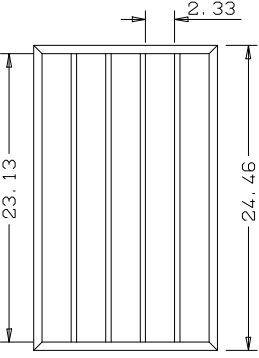
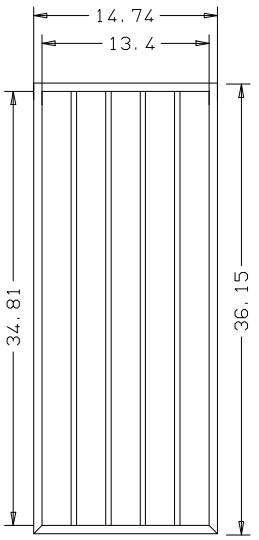
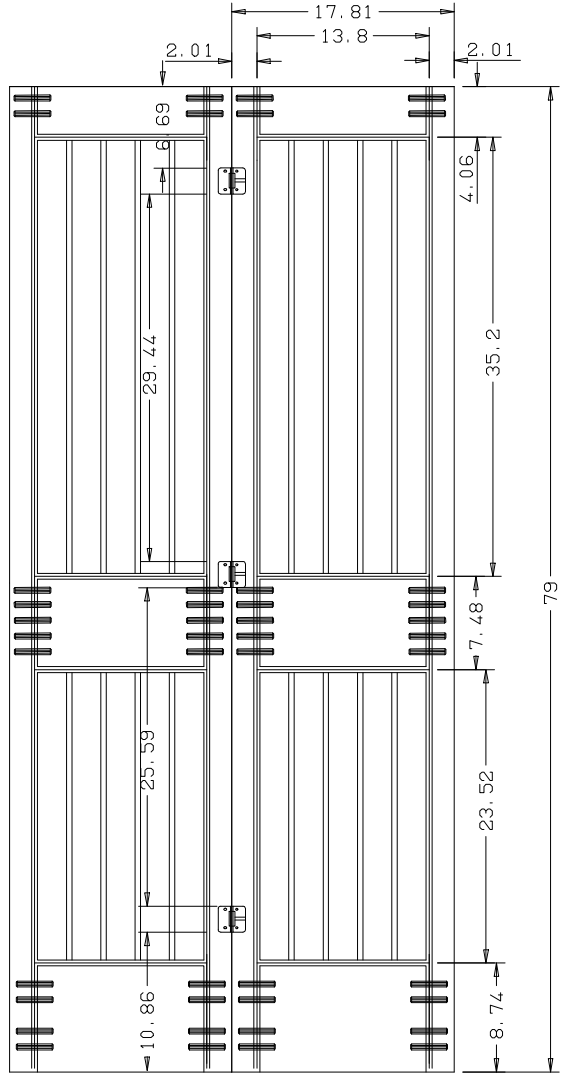

Dowel

Panel Profile

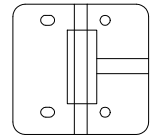

Hinge

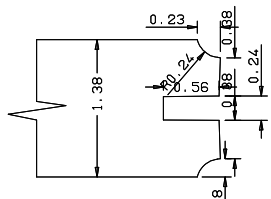
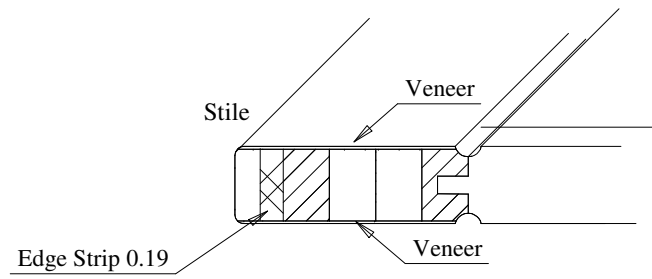

Profile

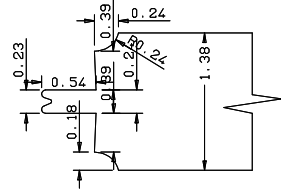

Profile

Titulo: RDM#1005 - 79" x 452,4 (17. 13-16) x 35mm - knotty						
Client	Square One					
Designer	Luiz Antonio Cirico	Approval	Charles	Reviewed by	Luiz Antonio	
Date	03-05-2022	Date	03-05-2022	Review Date	03-05-2022	