

Dowel

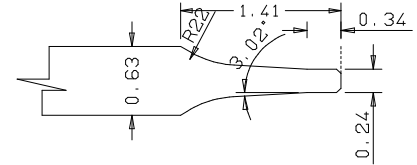

Panel Profile

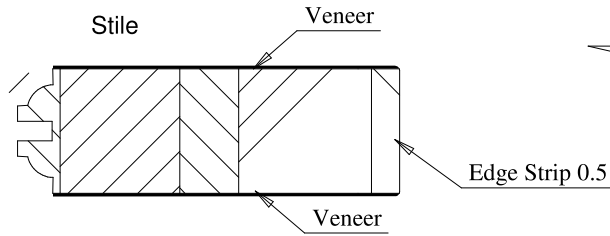
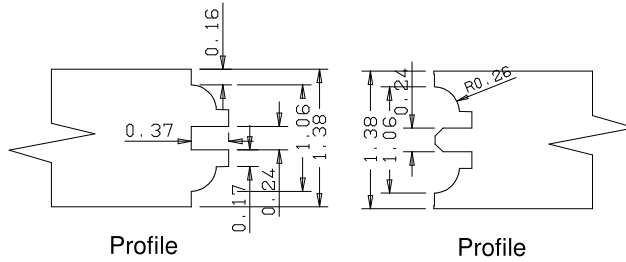

Profile

Profile

|     | A     | B     | C     | D |
|-----|-------|-------|-------|---|
| 36" | 27.65 | 11.97 | 11.81 |   |
| 34" | 25.65 | 10.97 | 10.82 |   |
| 32" | 23.65 | 9.97  | 9.80  |   |
| 30" | 21.65 | 8.97  | 8.81  |   |
| 28" | 19.65 | 7.97  | 7.83  |   |
| 26" | 17.65 | 6.97  | 6.81  |   |
| 24" | 15.65 | 5.97  | 5.82  |   |

Titulo: **RM#105 - 80" x 35mm - Clear - R2-36**

|  |          |                 |          |            |             |              |
|--|----------|-----------------|----------|------------|-------------|--------------|
|  | Client   | 963- Square One |          |            |             |              |
|  | Designer | Luiz Antônio    | Approval | Odirlei    | Reviewed by | Luiz Antônio |
|  | Date     | 23-01-2018      | Date     | 23-01-2018 | Review Date | 23-01-2018   |

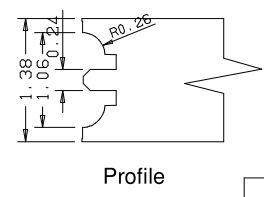
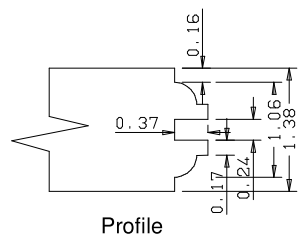
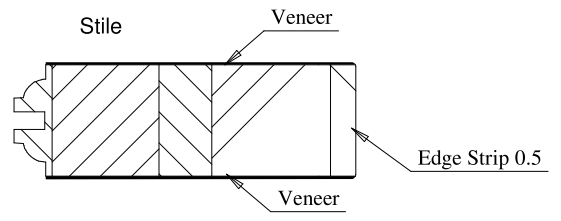
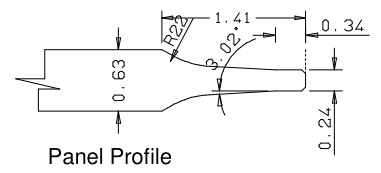
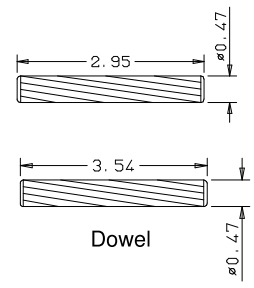
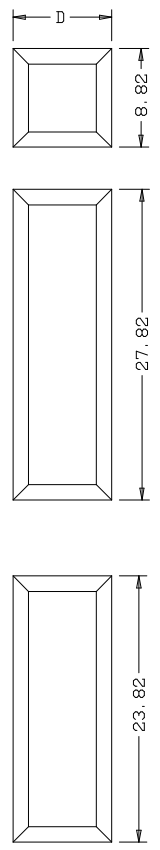
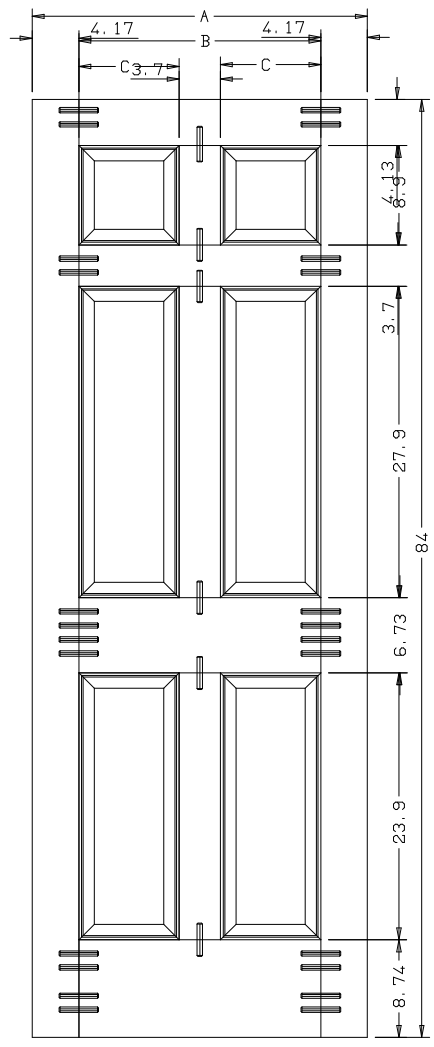

|     | A     | B     | C     | D |
|-----|-------|-------|-------|---|
| 36" | 27.65 | 11.97 | 11.81 |   |
| 34" | 25.65 | 10.97 | 10.82 |   |
| 32" | 23.65 | 9.97  | 9.80  |   |
| 30" | 21.65 | 8.97  | 8.81  |   |
| 28" | 19.65 | 7.97  | 7.83  |   |
| 26" | 17.65 | 6.97  | 6.81  |   |
| 24" | 15.65 | 5.97  | 5.82  |   |

|                                   |          |                 |              |            |
|-----------------------------------|----------|-----------------|--------------|------------|
| Titulo: <b>RM#105 - 84 x 35mm</b> |          |                 |              |            |
|                                   | Client   | 963- Square One |              |            |
|                                   | Designer | Luiz Antônio    | Approval     | Odirlei    |
|                                   | Date     | 23-01-2018      | Date         | 23-01-2018 |
|                                   |          | Reviewed by     | Luiz Antônio |            |
|                                   |          | Review Date     | 23-01-2018   |            |

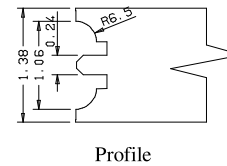
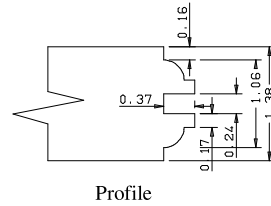
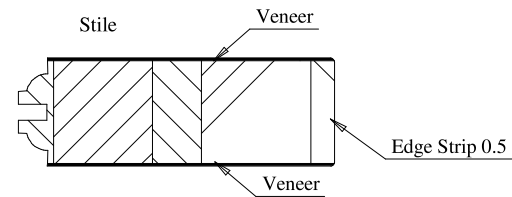
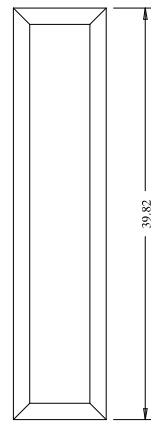
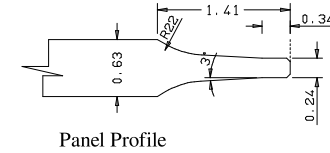
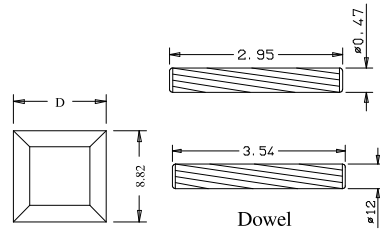
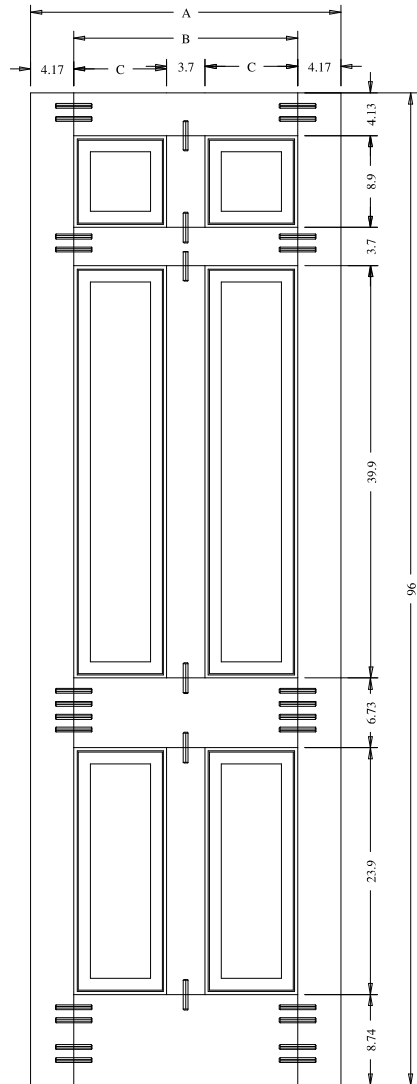

|     | A     | B     | C     | D |
|-----|-------|-------|-------|---|
| 36" | 27.65 | 11.97 | 11.81 |   |
| 34" | 25.65 | 10.97 | 10.82 |   |
| 32" | 23.65 | 9.97  | 9.80  |   |
| 30" | 21.65 | 8.97  | 8.81  |   |
| 28" | 19.65 | 7.97  | 7.83  |   |
| 26" | 17.65 | 6.97  | 6.81  |   |
| 24" | 15.65 | 5.97  | 5.82  |   |

|   |          |                 |          |            |                             |
|---|----------|-----------------|----------|------------|-----------------------------|
| Titulo: <b>RM#105 - 96" x 24 a 36" x 35mm</b> |          |                 |          |            |                             |
|   | Client   | 963- Square One |          |            |                             |
|   | Designer | Luiz Antônio    | Approval | Charles    | Reviewed by<br>Luiz Antônio |
|   | Date     | 26-03-2018      | Date     | 26-03-2018 | Review Date<br>26-03-2018   |

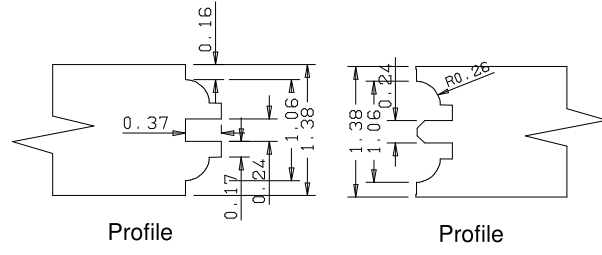
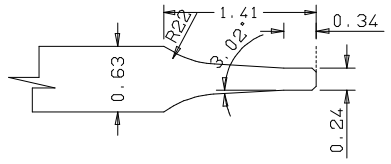
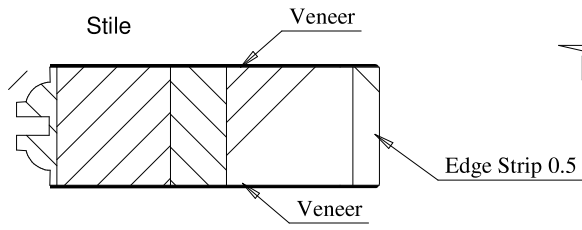
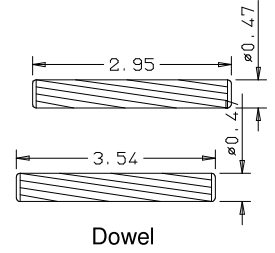
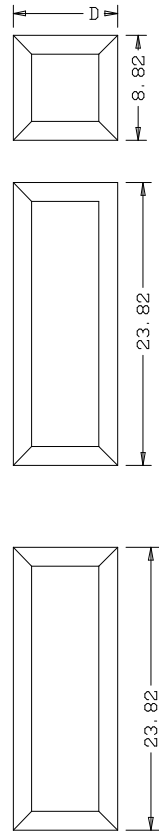
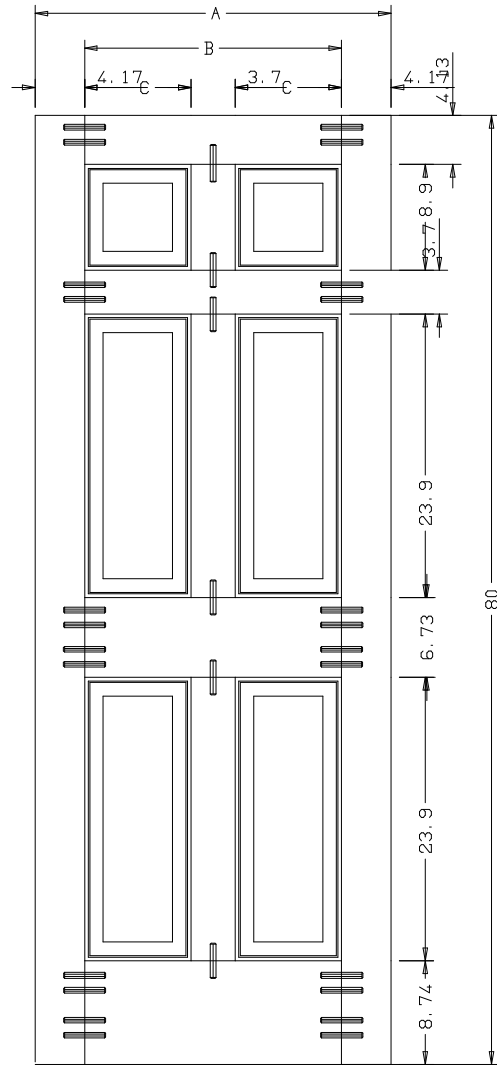

|     | A     | B     | C     | D |
|-----|-------|-------|-------|---|
| 36" | 27.65 | 11.97 | 11.81 |   |
| 34" | 25.65 | 10.97 | 10.82 |   |
| 32" | 23.65 | 9.97  | 9.80  |   |
| 30" | 21.65 | 8.97  | 8.81  |   |
| 28" | 19.65 | 7.97  | 7.83  |   |
| 26" | 17.65 | 6.97  | 6.81  |   |
| 24" | 15.65 | 5.97  | 5.82  |   |

|  |          |                 |          |            |                             |
|--|----------|-----------------|----------|------------|-----------------------------|
| Titulo: <b>RM#105 - 80" x 35mm - Clear - R2-36</b> |          |                 |          |            |                             |
|  | Client   | 963- Square One |          |            |                             |
|  | Designer | Luiz Antônio    | Approval | Odirlei    | Reviewed by<br>Luiz Antônio |
|  | Date     | 23-01-2018      | Date     | 23-01-2018 | Review Date<br>23-01-2018   |

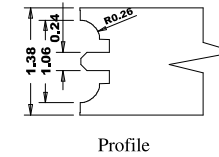
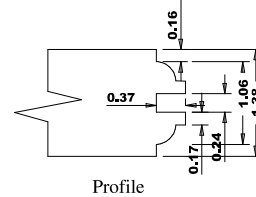
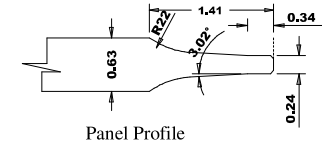
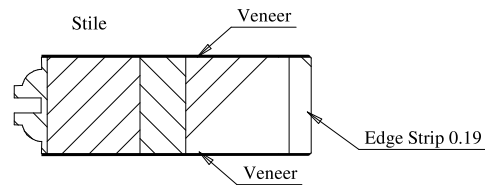
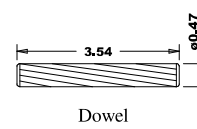
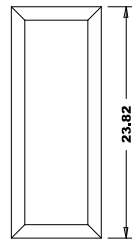
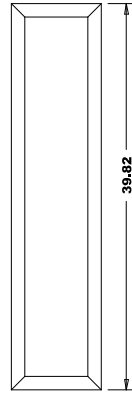
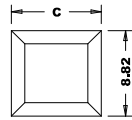
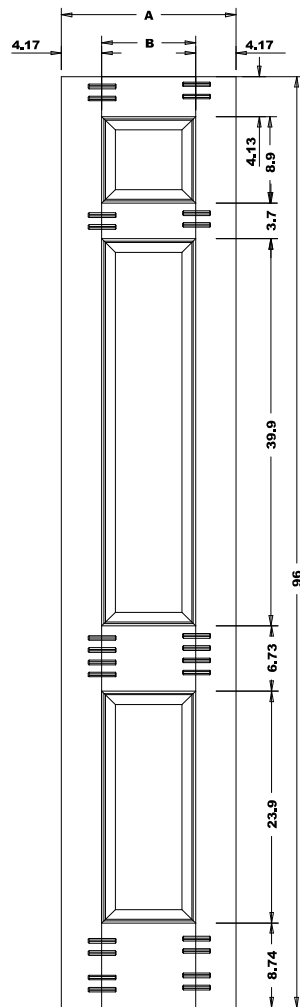

|              | A     | B | C     |
|--------------|-------|---|-------|
| 22"(558,8mm) | 346,8 |   | 342,8 |
| 20"(508mm)   | 296   |   | 292   |
| 18"(457.2mm) | 245.2 |   | 241.2 |

Titulo: **RM#136 - 96 x 18 a 22 x 35mm - Clear**

|          |                 |          |            |             |              |
|----------|-----------------|----------|------------|-------------|--------------|
| Client   | 963- Square One |          |            |             |              |
| Designer | Luiz Antônio    | Approval | Odirlei    | Reviewed by | Luiz Antônio |
| Date     | 13-02-2020      | Date     | 13-02-2020 | Review Date | 13-02-2020   |

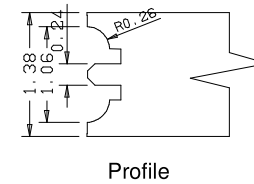
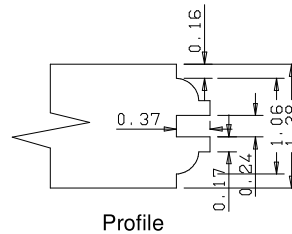
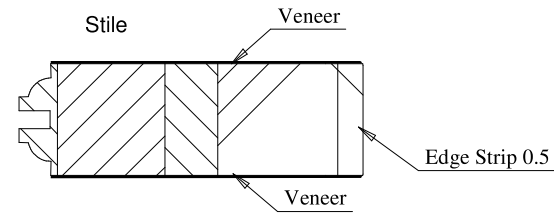
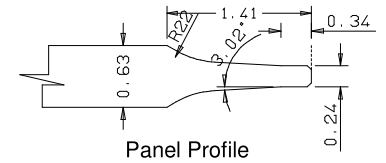
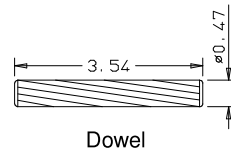
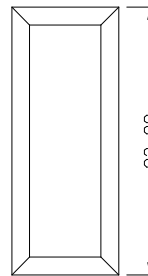
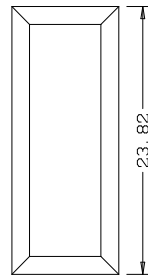
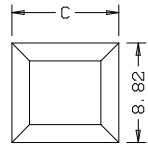
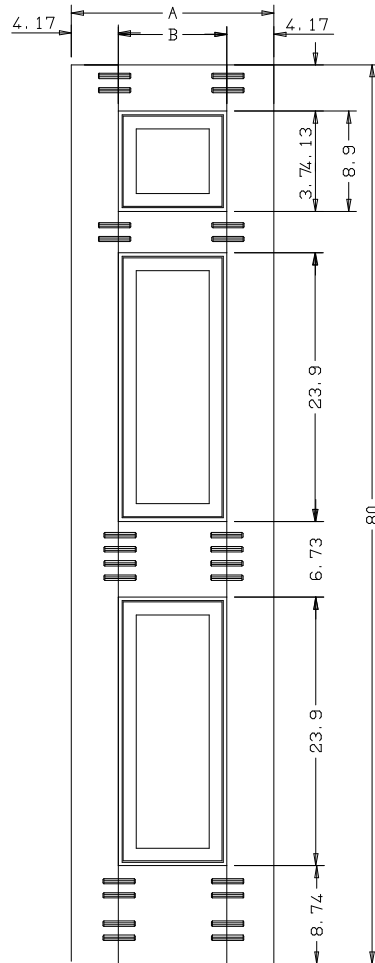

|     | A     | B     | C |
|-----|-------|-------|---|
| 22" | 13.65 | 13.61 |   |
| 20" | 11.65 | 11.61 |   |
| 18" | 9.65  | 9.61  |   |

|  |                 |      |            |             |              |
|--|-----------------|------|------------|-------------|--------------|
| Título: <b>RM#136 - 80" x 18" A 22" X 35mm - CLEAR</b> |                 |      |            |             |              |
| Client   | 963- Square One |      | Approval   | Reviewed by |              |
| Designer   | Luiz Antônio    | Date | 23-06-2018 | Charles     | Luiz Antônio |
| Date   | 23-06-2018      | Date | 23-06-2018 | Review Date | 23-06-2018   |